

ZOLLATRICI

ROOTBALLING MACHINES
ARRACHEUSE DE MOTTES
ENCEPELLONADORAS
BALLENSCHNEIDEMASCHINEN



FZ 50



23



900



0 - 4 km/h



Lombardini FOCS 1003



Ø 18, 20, 22, 25,
27, 30, 32, 35,
37, 40, 45, 50 cm



Dimensioni:

- Lunghezza: 212 cm
- Larghezza: Allargamento idraulico da 64 cm a 74 cm
- Altezza: 187 cm

Cingoli:

in gomma da 18 cm

Motore:

Lombardini, diesel 3 cilindri raffreddato a liquido

Potenza:

23 CV a 3000 giri/min

Cilindrata:

1003 cc



Measurements:

- Length: 212 cm (83.46 in)
- Width: Hydraulic adjustable from 64 cm (25.20 in) to 74 cm (29.13 in)
- Height: 187 cm (73.62 in)

Belt tracks:

in rubber of 18 cm (7.09 in)

Engine:

Lombardini, diesel 3 cylinders, water cooled

Power:

23 HP at 3000 RPM

Displacement:

1003 cc



Dimensions:

- Longueur: 212 cm
- Largeur: Élargissement hydraulique de 64 cm à 74 cm
- Hauteur: 187 cm

Chenilles:

en caoutchouc de 18 cm

Moteur:

Lombardini, 3-cylindres diesel, refroidi par liquide

Puissance:

23 CV à 3000 TR/MIN

Déplacement:

1003 cc



Dimensiones:

- Longitud: 212 cm
- Anchura: Enhanche hidráulico de 64 cm a 74 cm
- Altura: 187 cm

Orugas:

de goma de 18 cm

Motor:

Lombardini, 3-cilindros diesel, enfriamiento líquido

Potencia:

23 CV a 3000 RPM

Desplazamiento:

1003 cc



Abmessungen:

- Länge: 212 cm
- Breite: Hydraulisch einstellbare Breite von 64 cm bis 74 cm
- Höhe: 187 cm

Gummiketten:

18 cm

Motor:

Lombardini, diesel 3Zylindern, Flüssigkeitsgekühlt

Macht:

23 PS bei 3000 u/MIN

Verdrängung:

1003 cc



25



1950



0 - 3 km/h



0 - 6 km/h



Kubota D-1105



Ø 25, 30, 35, 40,
45, 50, 55, 60, 65,
70, 75, 80, 90 cm

***OPTIONAL** pag. 10

 <p>Dimensioni:</p> <ul style="list-style-type: none"> • Lunghezza: 241 cm • Larghezza: Allargamento idraulico da 84 cm a 112 cm • Altezza: 226 cm 	<p>Cingoli: in gomma da 23 cm</p> <p>Potenza: 25 CV a 3000 giri/min</p>	<p>Motore: Kubota, diesel 3 cilindri raffreddato a liquido</p> <p>Cilindrata: 1105 cc</p>	<ul style="list-style-type: none"> • Rotazione gruppo di taglio 30° DX e 30° SX • Slitta baricentrica corsa 30 cm
 <p>Measurements:</p> <ul style="list-style-type: none"> • Length: 241 cm (94.88 in) • Width: Hydraulic adjustable from 84 cm (33.07 in) to 112 cm (44.09 in) • Height: 226 cm (88.98 in) 	<p>Belt tracks: in rubber of 23 cm (9.06 in)</p> <p>Power: 25 HP at 3000 RPM</p>	<p>Engine: Kubota, diesel 3 cylinders, water cooled</p> <p>Displacement: 1105 cc</p>	<ul style="list-style-type: none"> • Digging unit swivelling of 30° right and 30° left • Center of gravity displacement of 30 cm (18.81 in)
 <p>Dimensions:</p> <ul style="list-style-type: none"> • Longueur: 241 cm • Largeur: Élargissement hydraulique de 84 cm à 112 cm • Hauteur: 226 cm 	<p>Chenilles: en caoutchouc de 23 cm</p> <p>Puissance: 25 CV à 3000 TR/MIN</p>	<p>Moteur: Kubota, 3-cylindres diesel, refroidi par liquide</p> <p>Déplacement: 1105 cc</p>	<ul style="list-style-type: none"> • Rotation de l'unité de coupe 30° droite et 30° gauche • Déplacement du centre de gravité 30 cm
 <p>Dimensiones:</p> <ul style="list-style-type: none"> • Longitud: 241 cm • Anchura: Enhanche hidráulico de 84 cm a 112 cm • Altura: 226 cm 	<p>Orugas: de goma de 23 cm</p> <p>Potencia: 25 CV a 3000 RPM</p>	<p>Motor: Kubota, 3-cilindros diesel, enfriamiento líquido</p> <p>Desplazamiento: 1105 cc</p>	<ul style="list-style-type: none"> • Rotación de la unidad de corte 30° derecha y 30° izquierda • Centro de desplazamiento de gravedad de 30 cm
 <p>Abmessungen:</p> <ul style="list-style-type: none"> • Länge: 241 cm • Breite: Hydraulisch einstellbare Breite von 84 cm bis 112 cm • Höhe: 226 cm 	<p>Gummiketten: 23 cm</p> <p>Macht: 25 PS bei 3000 u/MIN</p>	<p>Motor: Kubota, diesel 3Zylindern, Flüssigkeitsgekühlt</p> <p>Verdrängung: 1105 cc</p>	<ul style="list-style-type: none"> • Drehung der Schneidgruppe 30° nach rechts und 30° nach links • Schwerpunktverschiebung von 30 cm

FZ 110



35.6



1950



0 - 4 km/h



0 - 8 km/h



Kubota V-1505-E



Ø 25, 30, 35, 40, 45,
50, 55, 60, 65, 70, 75,
80, 90, 100, 110 cm

***OPTIONAL** pag. 10



Dimensioni:

- Lunghezza: 241 cm
- Larghezza: Allargamento idraulico da 90 cm a 114 cm
- Altezza: 226 cm

Cingoli:

in gomma da 25 cm

Potenza:

35.6 CV a 3000 giri/min

Motore:

Kubota, diesel 4 cilindri raffreddato a liquido

Cilindrata:

1505 cc

- Rotazione gruppo di taglio 30° DX e 30° SX
- Slitta baricentrica corsa 46 cm



Measurements:

- Length: 241 cm (94.88 in)
- Width: Hydraulic adjustable from 90 cm (35.43 in) to 114 cm (44.88 in)
- Height: 226 cm (88.98 in)

Belt tracks:

in rubber of 25 cm (9.84 in)

Power:

35.6 HP at 3000 RPM

Engine:

Kubota, diesel 4 cylinders, water cooled

Displacement:

1505 cc

- Digging unit swivelling of 30° right and 30° left
- Center of gravity displacement of 46 cm (18.11 in)



Dimensions:

- Longueur: 241 cm
- Largeur: Élargissement hydraulique de 90 cm à 114 cm
- Hauteur: 226 cm

Chenilles:

en caoutchouc de 25 cm

Puissance:

35.6 CV à 3000 TR/MIN

Moteur:

Kubota, 4-cylindres diesel, refroidi par liquide

Déplacement:

1505 cc

- Rotation de l'unité de coupe 30° droite et 30° gauche
- Déplacement du centre de gravité 46 cm



Dimensiones:

- Longitud: 241 cm
- Anchura: Enanche hidráulico de 90 cm a 114 cm
- Altura: 226 cm

Orugas:

de goma de 25 cm

Potencia:

35.6 CV a 3000 RPM

Motor:

Kubota, 4-cilindros diesel, enfriamiento líquido

Desplazamiento:

1505 cc

- Rotación de la unidad de corte 30° derecha y 30° izquierda
- Centro de desplazamiento de gravedad de 46 cm



Abmessungen:

- Länge: 241 cm
- Breite: Hydraulisch einstellbare Breite von 90 cm bis 114 cm
- Höhe: 226 cm

Gummiketten:

25 cm

Macht:

35.6 PS bei 3000 u/MIN

Motor:

Kubota, diesel 4Zylindern, Flüssigkeitsgekühlt

Verdrängung:

1505 cc

- Drehung der Schneidgruppe 30° nach rechts und 30° nach links
- Schwerpunktverschiebung von 46 cm

FZ 110 PLUS



44.9



1950



0 - 4 km/h



0 - 8 km/h



Kubota V-1505-E Turbo
Kubota V-2403 (TPEM EPA)



Ø 25, 30, 35, 40, 45, 50,
55, 60, 65, 70, 75, 80, 90,
100, 110, 120, 130 cm

***OPTIONAL** pag. 10

 <p>Dimensioni:</p> <ul style="list-style-type: none"> • Lunghezza: 241 cm • Larghezza: Allargamento idraulico da 90 cm a 114 cm • Altezza: 226 cm 	<p>Cingoli: in gomma da 25 cm</p> <p>Potenza: 44.9 CV a 3000 giri/min</p>	<p>Motore: Kubota, diesel 4 cilindri raffreddato a liquido</p> <p>Cilindrata: 1505 cc Turbo</p>	<ul style="list-style-type: none"> • Rotazione gruppo di taglio 30° DX e 30° SX • Slitta baricentrica corsa 46 cm
 <p>Measurements:</p> <ul style="list-style-type: none"> • Length: 241 cm (94.88 in) • Width: Hydraulic adjustable from 90 cm (35.43 in) to 114 cm (44.88 in) • Height: 226 cm (88.98 in) 	<p>Belt tracks: in rubber of 25 cm (9.84 in)</p> <p>Power: 44.9 HP at 3000 RPM</p>	<p>Engine: Kubota, diesel 4 cylinders, water cooled</p> <p>Displacement: 1505 cc Turbo</p>	<ul style="list-style-type: none"> • Digging unit swivelling of 30° right and 30° left • Center of gravity displacement of 46 cm (18.11 in)
 <p>Dimensions:</p> <ul style="list-style-type: none"> • Longueur: 241 cm • Largeur: Élargissement hydraulique de 90 cm à 114 cm • Hauteur: 226 cm 	<p>Chenilles: en caoutchouc de 25 cm</p> <p>Puissance: 44.9 CV à 3000 TR/MIN</p>	<p>Moteur: Kubota, 4-cylindres diesel, refroidi par liquide</p> <p>Déplacement: 1505 cc Turbo</p>	<ul style="list-style-type: none"> • Rotation de l'unité de coupe 30° droite et 30° gauche • Déplacement du centre de gravité 46 cm
 <p>Dimensiones:</p> <ul style="list-style-type: none"> • Longitud: 241 cm • Anchura: Enhanche hidráulico de 90 cm a 114 cm • Altura: 226 cm 	<p>Orugas: de goma de 25 cm</p> <p>Potencia: 44.9 CV a 3000 RPM</p>	<p>Motor: Kubota, 4-cilindros diesel, enfriamiento líquido</p> <p>Desplazamiento: 1505 cc Turbo</p>	<ul style="list-style-type: none"> • Rotación de la unidad de corte 30° derecha y 30° izquierda • Centro de desplazamiento de gravedad de 46 cm
 <p>Abmessungen:</p> <ul style="list-style-type: none"> • Länge: 241 cm • Breite: Hydraulisch einstellbare Breite von 90 cm bis 114 cm • Höhe: 226 cm 	<p>Gummiketten: 25 cm</p> <p>Macht: 44.9 PS bei 3000 u/MIN</p>	<p>Motor: Kubota, diesel 4Zylindern, Flüssigkeitsgekühlt</p> <p>Verdrängung: 1505 cc Turbo</p>	<ul style="list-style-type: none"> • Drehung der Schneidgruppe 30° nach rechts und 30° nach links • Schwerpunktverschiebung von 46 cm

FZ 120



35.6



1950



0 - 4 km/h



0 - 8 km/h



Kubota V-1505-E

Ø 25, 30, 35, 40, 45,
50, 55, 60, 65, 70, 75,
80, 90, 100, 110 cm

*OPTIONAL pag. 10



Dimensioni:

- Lunghezza: 241 cm
- Larghezza: Allargamento idraulico da 90 cm a 114 cm
- Altezza: 226 cm

Cingoli:

in gomma da 25 cm

Potenza:

35.6 CV a 3000 giri/min

Motore:

Kubota, diesel 4 cilindri raffreddato a liquido

Cilindrata:

1505 cc

• Rotazione gruppo di taglio 30° DX e 30° SX

• Slitta baricentrica corsa 46 cm



Measurements:

- Length: 241 cm (94.88 in)
- Width: Hydraulic adjustable from 90 cm (35.43 in) to 114 cm (44.88 in)
- Height: 226 cm (88.98 in)

Belt tracks:

in rubber of 25 cm (9.84 in)

Power:

35.6 HP at 3000 RPM

Engine:

Kubota, diesel 4 cylinders, water cooled

Displacement:

1505 cc

• Digging unit swivelling of 30° right and 30° left

• Center of gravity displacement of 46 cm (18.11 in)



Dimensions:

- Longueur: 241 cm
- Largeur: Élargissement hydraulique de 90 cm à 114 cm
- Hauteur: 226 cm

Chenilles:

en caoutchouc de 25 cm

Puissance:

35.6 CV à 3000 TR/MIN

Moteur:

Kubota, 4-cylindres diesel, refroidi par liquide

Déplacement:

1505 cc

• Rotation de l'unité de coupe 30° droite et 30° gauche

• Déplacement du centre de gravité 46 cm



Dimensiones:

- Longitud: 241 cm
- Anchura: Enanche hidráulico de 90 cm a 114 cm
- Altura: 226 cm

Orugas:

de goma de 25 cm

Potencia:

35.6 CV a 3000 RPM

Motor:

Kubota, 4-cilindros diesel, enfriamiento líquido

Desplazamiento:

1505 cc

• Rotación de la unidad de corte 30° derecha y 30° izquierda

• Centro de desplazamiento de gravedad de 46 cm



Abmessungen:

- Länge: 241 cm
- Breite: Hydraulisch einstellbare Breite von 90 cm bis 114 cm
- Höhe: 226 cm

Gummiketten:

25 cm

Macht:

35.6 PS bei 3000 u/MIN

Motor:

Kubota, diesel 4Zylindern, Flüssigkeitsgekühlt

Verdrängung:

1505 cc

• Drehung der Schneidegruppe 30° nach rechts und 30° nach links

• Schwerpunktverschiebung von 46 cm

FZ 120 PLUS



44.9



1950



0 - 4 km/h



0 - 8 km/h



Kubota V-1505-E Turbo
Kubota V-2403 (TPEM EPA)

***OPTIONAL pag. 10**



Ø 25, 30, 35, 40, 45, 50,
55, 60, 65, 70, 75, 80, 90,
100, 110, 120, 130 cm

	<p>Dimensioni:</p> <ul style="list-style-type: none"> • Lunghezza: 241 cm • Larghezza: Allargamento idraulico da 90 cm a 114 cm • Altezza: 226 cm 	<p>Cingoli: in gomma da 25 cm</p> <p>Potenza: 44.9 CV a 3000 giri/min</p>	<p>Motore: Kubota, diesel 4 cilindri raffreddato a liquido</p> <p>Cilindrata: 1505 cc Turbo</p>	<ul style="list-style-type: none"> • Rotazione gruppo di taglio 30° DX e 30° SX • Slitta baricentrica corsa 46 cm
	<p>Measurements:</p> <ul style="list-style-type: none"> • Length: 241 cm (94.88 in) • Width: Hydraulic adjustable from 90 cm (35.43 in) to 114 cm (44.88 in) • Height: 226 cm (88.98 in) 	<p>Belt tracks: in rubber of 25 cm (9.84 in)</p> <p>Power: 44.9 HP at 3000 RPM</p>	<p>Engine: Kubota, diesel 4 cylinders, water cooled</p> <p>Displacement: 1505 cc Turbo</p>	<ul style="list-style-type: none"> • Digging unit swivelling of 30° right and 30° left • Center of gravity displacement of 46 cm (18.11 in)
	<p>Dimensions:</p> <ul style="list-style-type: none"> • Longueur: 241 cm • Largeur: Élargissement hydraulique de 90 cm à 114 cm • Hauteur: 226 cm 	<p>Chenilles: en caoutchouc de 25 cm</p> <p>Puissance: 44.9 CV à 3000 TR/MIN</p>	<p>Moteur: Kubota, 4-cylindres diesel, refroidi par liquide</p> <p>Déplacement: 1505 cc Turbo</p>	<ul style="list-style-type: none"> • Rotation de l'unité de coupe 30° droite et 30° gauche • Déplacement du centre de gravité 46 cm
	<p>Dimensiones:</p> <ul style="list-style-type: none"> • Longitud: 241 cm • Anchura: Enhanche hidráulico de 90 cm a 114 cm • Altura: 226 cm 	<p>Orugas: de goma de 25 cm</p> <p>Potencia: 44.9 CV a 3000 RPM</p>	<p>Motor: Kubota, 4-cilindros diesel, enfriamiento líquido</p> <p>Desplazamiento: 1505 cc Turbo</p>	<ul style="list-style-type: none"> • Rotación de la unidad de corte 30° derecha y 30° izquierda • Centro de desplazamiento de gravedad de 46 cm
	<p>Abmessungen:</p> <ul style="list-style-type: none"> • Länge: 241 cm • Breite: Hydraulisch einstellbare Breite von 90 cm bis 114 cm • Höhe: 226 cm 	<p>Gummiketten: 25 cm</p> <p>Macht: 44.9 PS bei 3000 u/MIN</p>	<p>Motor: Kubota, diesel 4Zylindern, Flüssigkeitsgekühlt</p> <p>Verdrängung: 1505 cc Turbo</p>	<ul style="list-style-type: none"> • Drehung der Schneidgruppe 30° nach rechts und 30° nach links • Schwerpunktverschiebung von 46 cm

FZ 161 T



59.8



3030



0 - 3 km/h



0 - 6 km/h



Kubota V-2403-T

Ø 40, 45, 50, 55, 60, 65,
70, 75, 80, 90, 100, 110,
120, 130, 140, 150, 160 cm

***OPTIONAL** pag. 10



Dimensioni:

- Lunghezza: 270 cm
- Larghezza: Allargamento idraulico da 112 cm a 162 cm
- Altezza: 235 cm

Cingoli:

in gomma da 28 cm

Potenza:

59.8 CV a 3000 giri/min

Motore:

Kubota, diesel 4 cilindri raffreddato a liquido

Cilindrata:

2403 cc

- Rotazione gruppo di taglio 30° DX e 30° SX
- Slitta baricentrica corsa 40 cm



Measurements:

- Length: 270 cm (106.30 in)
- Width: Hydraulic adjustable from 112 cm (44.09 in) to 162 cm (63.78 in)
- Height: 235 cm (92.52 in)

Belt tracks:

in rubber of 28 cm (11.02 in)

Power:

59.8 HP at 3000 RPM

Engine:

Kubota, diesel 4 cylinders, water cooled

Displacement:

2403 cc

- Digging unit swivelling of 30° right and 30° left
- Center of gravity displacement of 40 cm (15.75 in)



Dimensions:

- Longueur: 270 cm
- Largeur: Élargissement hydraulique de 112 cm à 162 cm
- Hauteur: 235 cm

Chenilles:

en caoutchouc de 28 cm

Puissance:

59.8 CV à 3000 TR/MIN

Moteur:

Kubota, 4-cylindres diesel, refroidi par liquide

Déplacement:

2403 cc

- Rotation de l'unité de coupe 30° droite et 30° gauche
- Déplacement du centre de gravité 40 cm



Dimensiones:

- Longitud: 270 cm
- Anchura: Enchanche hidráulico de 112 cm a 162 cm
- Altura: 235 cm

Orugas:

de goma de 28 cm

Potencia:

59.8 CV a 3000 RPM

Motor:

Kubota, 4-cilindros diesel, enfriamiento líquido

Desplazamiento:

2403 cc

- Rotación de la unidad de corte 30° derecha y 30° izquierda
- Centro de desplazamiento de gravedad de 40 cm



Abmessungen:

- Länge: 270 cm
- Breite: Hydraulisch einstellbare Breite von 112 cm bis 162 cm
- Höhe: 235 cm

Gummiketten:

28 cm

Macht:

59.8 PS bei 3000 u/MIN

Motor:

Kubota, diesel 4Zylindern, Flüssigkeitsgekühlt

Verdrängung:

2403 cc

- Drehung der Schneidegruppe 30° nach rechts und 30° nach links
- Schwerpunktverschiebung von 40 cm

FZ 200 AV



64.9



4700



0 - 3 km/h



0 - 6 km/h



Kubota V-2607-T

Ø 60, 65, 70, 75, 80, 90,
100, 110, 120, 130, 140,
150, 160, 170, 180, 200 cm

***OPTIONAL** pag. 10



	<p>Dimensioni:</p> <ul style="list-style-type: none"> • Lunghezza: 315 cm • Larghezza: Allargamento idraulico da 150 cm a 200 cm • Altezza: 246 cm 	<p>Cingoli: in gomma da 30 cm</p> <p>Potenza: 64.9 CV a 2800 giri/min</p>	<p>Motore: Kubota, diesel 4 cilindri raffreddato a liquido</p> <p>Cilindrata: 2607 cc Turbo</p>	<ul style="list-style-type: none"> • Braccio per lame idraulico DI SERIE • AV Alzata Verticale DI SERIE
	<p>Measurements:</p> <ul style="list-style-type: none"> • Length: 315 cm (124.02 in) • Width: Hydraulic adjustable from 150 cm (59.06 in) to 200 cm (78.74 in) • Height: 246 cm (96.85 in) 	<p>Belt tracks: in rubber of 30 cm (11.81 in)</p> <p>Power: 64.9 HP at 2800 RPM</p>	<p>Engine: Kubota, diesel 4 cylinders, water cooled</p> <p>Displacement: 2607 cc Turbo</p>	<ul style="list-style-type: none"> • Hydraulic blade arm INCLUDED • AV Vertical Lift INCLUDED
	<p>Dimensions:</p> <ul style="list-style-type: none"> • Longueur: 315 cm • Largeur: Élargissement hydraulique de 150 cm à 200 cm • Hauteur: 246 cm 	<p>Chenilles: en caoutchouc de 30 cm</p> <p>Puissance: 64.9 CV à 2800 TR/MIN</p>	<p>Moteur: Kubota, 4-cylindres diesel, refroidi par liquide</p> <p>Déplacement: 2607 cc Turbo</p>	<ul style="list-style-type: none"> • Bras pour lame hydraulique DE SÉRIE • AV Élévation verticale DE SÉRIE
	<p>Dimensiones:</p> <ul style="list-style-type: none"> • Longitud: 315 cm • Anchura: Enhanche hidráulico de 150 cm a 200 cm • Altura: 246 cm 	<p>Orugas: de goma de 30 cm</p> <p>Potencia: 64.9 CV a 2800 RPM</p>	<p>Motor: Kubota, 4-cilindros diesel, enfriamiento líquido</p> <p>Desplazamiento: 2607 cc Turbo</p>	<ul style="list-style-type: none"> • Brazo hidráulico para cuchillas DE SERIE • AV Elevación vertical DE SERIE
	<p>Abmessungen:</p> <ul style="list-style-type: none"> • Länge: 315 cm • Breite: Hydraulisch einstellbare Breite von 150 cm bis 200 cm • Höhe: 246 cm 	<p>Gummiketten: 30 cm</p> <p>Macht: 64.9 PS bei 2800 u/MIN</p>	<p>Motor: Kubota, diesel 4Zylindern, Flüssigkeitsgekühlt</p> <p>Verdrängung: 2607 cc Turbo</p>	<ul style="list-style-type: none"> • Hydraulischer Messer Arm EINGESCHLOSSEN • AV Hebung EINGESCHLOSSEN

OPTIONAL FZ



1

BRACCIO MECCANICO PER LAME

- Mechanic blade arm for blades
- Bras mécanique pour lames
- Brazo mecánico para cuchillas
- Mechanischer Arm fuer Messer

BRACCIO IDRAULICO PER LAME

- Hydraulic blade arm for blades
- Bras hydraulique pour lames
- Brazo hidraulico para cuchillas
- Hydraulischer Arm für Messer

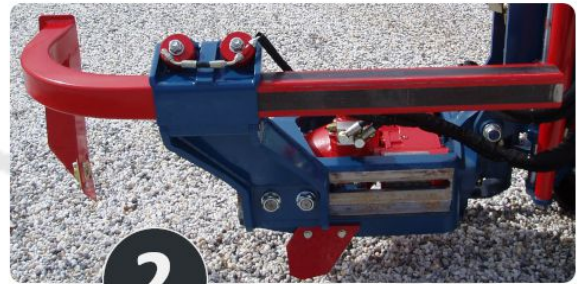

2



3

TENDINGOLO A GRASSO

- Rubber belt track tensioning by grease cylinder
- Tende-chenille à gras
- Tende-orugas con grasa
- Kettenspanner mit Schmiere

4



AV - ALZATA VERTICALE

- AV - Vertical lift
- AV - Levée verticale
- AV - Elevación vertical
- AV - Senkrechter Hub

5

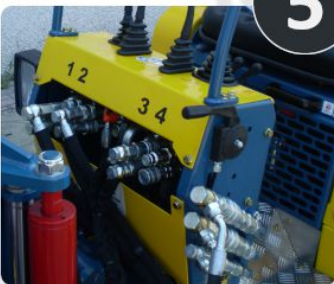

SR - SGANCIO RAPIDO PER ACCESSORI (*)

- SR - Quick relase system for accessories (*)
- SR - Largage rapide pour les accessoires (*)
- SR - Desenganche rápido para los accesorios (*)
- SR - Schnelle Auslösung für Zubehör (*)

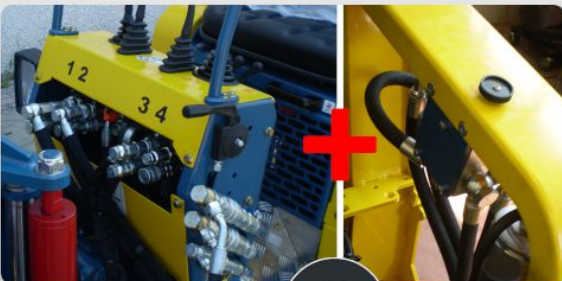

6

SR3P - SGANCIO RAPIDO CON 3a POMPA E VALVOLA REGOLATRICE DI VELOCITÀ (**)

- SR3P - Quick release system for accessories with 3rd pump and speed regulation valve (**)
- SR3P - Largage rapide avec 3ème pompe et vanne de régulation de vitesse (**)
- SR3P - Desenganche rápido con tercera bomba y válvula de ajuste de velocidad (**)
- SR3P - Schnelle Auslösung mit 3. Pumpe und Geschwindigkeit einstellventil (**)

OPTIONAL FZ

	1	2	3	4	5	6
FZ 50	✗	✗	✗	✗	✗	✗
FZ 90	✗	✗	✓	✓ 35 CM	✓	✓
FZ 110	✓ 30-130 CM	✓ 30-130 CM	✓	✓ 35 CM	✓	✓
FZ 110 PLUS	✓ 30-130 CM	✓ 30-130 CM	✓	✓ 35 CM	✓	✓
FZ 120	✓ 30-130 CM	✓ 30-130 CM	✓	✓ 35 CM	✓	✓
FZ 120 PLUS	✓ 30-130 CM	✓ 30-130 CM	✓	✓ 35 CM	✓	✓
FZ 161 T	✓ 40-160 CM	✓ 40-160 CM	✓	✓ 50 CM	✓	✓
FZ 200 AV	✗	✓ 60-200 CM	✓	✓ 70 CM	✗	✗

✓ DISPONIBILE / AVAILABLE / DISPONIBLE / DISPONIBLE / VERFÜGBAR

✗ NON DISPONIBILE / NOT AVAILABLE / NON DISPONIBLE / NO DISPONIBLE / NICHT VERFÜGBAR

OPTIONAL FZ

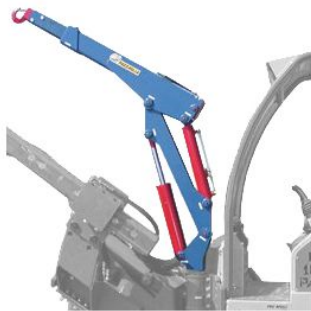

B10 / B12 / B15

BRACCIO GRU

- Crane
- Bras de grue
- Brazo de grúa
- Hebekran

B10 --> **FZ 90 - FZ 110 - FZ 110 PLUS**
FZ 120 - FZ 120 PLUS

B12 --> **FZ 161 T**

B15 --> **FZ 200 AV**

CP150 / CP300 *

CESTA DI POTATURA

- Pruning platform
- Plateforme de taille
- Plataforma de poda
- Schneidebühne

FZ 90 - FZ 110 - FZ 110 PLUS -
FZ 161 T



ES160 * / ES200 *

BRACCIO ESCAVATORE

- Excavator
- Bras excavateur
- Brazo excavador
- Gräberarm

ES160 --> **FZ 90 - FZ 110 - FZ 110 PLUS -**
FZ 120 - FZ 120 PLUS - FZ 161 T

LP / LPR 350

LEGAPIANTE

- Tree binder
- Lieuse de plantes
- Atadora de plantas
- Pflanzenbinder



TVP*

PIANTAPALI

- Pole driver
- Inséreuse de piquets
- Plantadora de palos
- Pfostenstecker

**FZ 90 - FZ 110 - FZ 110 PLUS -
FZ 120 - FZ 120 PLUS - FZ 161 T**



TV*

TRIVELLA

- Auger
- Tarière
- Barreno
- Erdbohrer

**FZ 90 - FZ 110 - FZ 110 PLUS -
FZ 120 - FZ 120 PLUS - FZ 161 T**



TVC*

PIANTACANNE

- Cane driver
- Inséreuse de bambous
- Plantadora de bambu
- Bambustecker

**FZ 90 - FZ 110 - FZ 110 PLUS -
FZ 120 - FZ 120 PLUS - FZ 161 T**



*** SR**

OPTIONAL FZ



FC*

FRESACEPPI

- Trunk chipper
- Fraiseuse de souches
- Fresa para cepas
- Fräsgerät für Holzklötze

**FZ 90 - FZ 110 - FZ 110 PLUS -
FZ 120 - FZ 120 PLUS - FZ 161 T**

CT20**

CATENARIA

- Trencher
- Trancheuse
- Zanjadora
- Grabekette

**FZ 90 - FZ 110 - FZ 110 PLUS -
FZ 120 - FZ 120 PLUS - FZ 161 T**



TE**

TRINCIA

- Flail mower
- Bras coupeur avant
- Brazo cortador anterior
- Vorderschneidearm

**FZ 90 - FZ 110 - FZ 110 PLUS -
FZ 120 - FZ 120 PLUS - FZ 161 T**

TE300**

BRACCIO TRINCIA

- Mowing arm
- Bras coupeur
- Brazo cortador
- Schneidearm

**FZ 90 - FZ 110 - FZ 110 PLUS -
FZ 120 - FZ 120 PLUS - FZ 161 T**



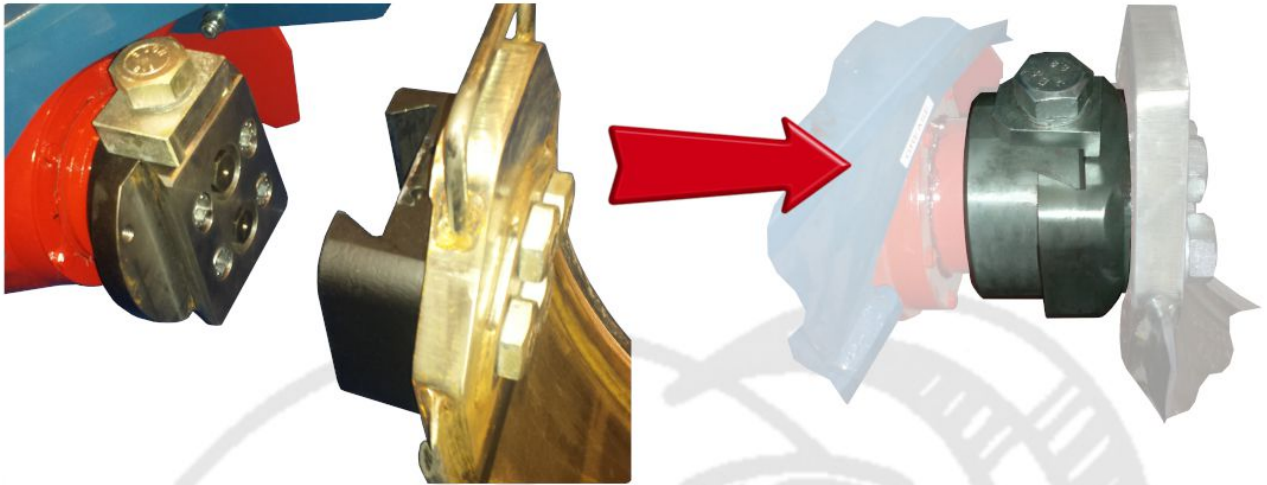

QRB 120 / QRB 200

SGANCIO RAPIDO PER LAME

- Quick release blade system
- Changement rapide des lames
- Cierre rápido para cuchillas
- Schnellveröffentlichung für messer

QRB 120 --> FZ 90 - FZ 110 - FZ 110 PLUS -
FZ 120 - FZ 120 PLUS

QRB 200 --> FZ 161 T - FZ 200 AV



- 1 - Inserire la lama
- 2 - Ruotare il dado di bloccaggio
- 3 - Avvitare la vite



- 1 - Insert the blade
- 2 - Turn the locking nut
- 3 - Tighten the bolt



- 1 - Insérer la lame
- 2 - Tournez l'écrou de blocage
- 3 - Serrez le boulon



- 1 - Insertar la cuchilla
- 2 - Girar la tuerca de bloqueo
- 3 - Apretar el perno



- 1 - Setzen Sie die Klinge ein
- 2 - Die Sicherungsmutter drehen
- 3 - Ziehen Sie die Schraube fest

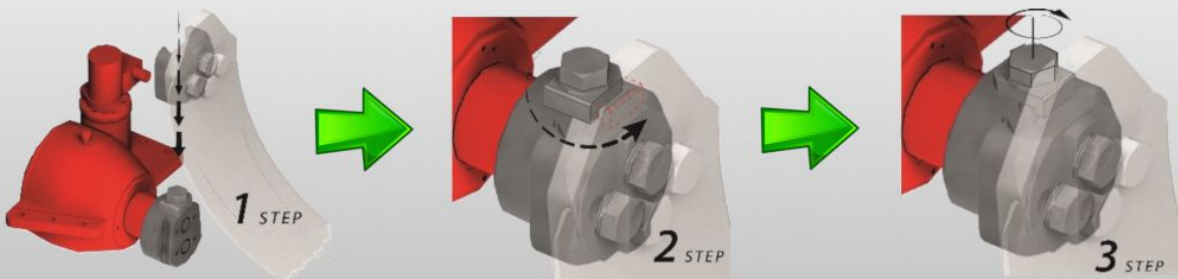



PINZE TRASPORTO VASI

CONTAINER MOVING GRABS

PINCE DE TRANSPORT DE POTS

PINZA DE TRANSPORTE DE MACETAS

TRANSPORTZANGE FÜR TÖPFE



PZL 900



24.8



1070



0 - 13 km/h



Kubota D-902



OPTIONAL
0 - 8,5 km/h



Dimensioni:

- Lunghezza: 235 cm
- Larghezza: 95 cm
- Altezza: 228 cm

Ruote:

23x8.5-12

Motore:

Kubota, diesel 3 cilindri
raffreddato a liquido

Potenza:

24.8 CV

Cilindrata:

902 cc



Measurements:

- Length: 235 cm (95.52 in)
- Width: 95 cm (37.40 in)
- Height: 228 cm (89.76 in)

Wheels:

23x8.5-12

Engine:

Kubota, diesel 3
cylinders, water cooled

Power:

24.8 HP

Displacement:

902 cc



Dimensions:

- Longueur: 235 cm
- Largeur: 95 cm
- Hauteur: 228 cm

Roues:

23x8.5-12

Moteur:

Kubota, 3-cylindres
diesel, refroidi par liquide

Puissance:

24.8 CV

Déplacement:

902 cc



Dimensiones:

- Longitud: 235 cm
- Anchura: 95 cm
- Altura: 228 cm

Ruedas:

23x8.5-12

Motor:

Kubota, 3-cilindros
diesel, enfriamiento líquido

Potencia:

24.8 CV

Desplazamiento:

902 cc



Abmessungen:

- Länge: 235 cm
- Breite: 95 cm
- Höhe: 228 cm

Räder:

23x8.5-12

Motor:

Kubota, diesel 3Zylindern,
Flüssigkeitsgekühlt

Macht:

24.8 PS

Verdrängung:

902 cc

PZL 1200



24.8



1100



0 - 13 km/h



Kubota D-902



OPTIONAL
0 - 8,5 km/h



Dimensioni:

- Lunghezza: 322 cm
- Larghezza: 95 cm
- Altezza: 228 cm

Ruote:

23x8.5-12

Motore:

Kubota, diesel 3 cilindri raffreddato a liquido

Potenza:

24.8 CV

Cilindrata:

902 cc



Measurements:

- Length: 322 cm (126.77 in)
- Width: 95 cm (37.40 in)
- Height: 228 cm (89.76 in)

Wheels:

23x8.5-12

Engine:

Kubota, diesel 3 cylinders, water cooled

Power:

24.8 HP

Displacement:

902 cc



Dimensions:

- Longueur: 322 cm
- Largeur: 95 cm
- Hauteur: 228 cm

Roues:

23x8.5-12

Moteur:

Kubota, 3-cylindres diesel, refroidi par liquide

Puissance:

24.8 CV

Déplacement:

902 cc



Dimensiones:

- Longitud: 322 cm
- Anchura: 95 cm
- Altura: 228 cm

Ruedas:

23x8.5-12

Motor:

Kubota, 3-cilindros diesel, enfriamiento líquido

Potencia:

24.8 CV

Desplazamiento:

902 cc



Abmessungen:

- Länge: 322 cm
- Breite: 95 cm
- Höhe: 228 cm

Räder:

23x8.5-12

Motor:

Kubota, diesel 3Zylindern, Flüssigkeitsgekühlt

Macht:

24.8 PS

Verdrängung:

902 cc

PZL 900 T



24.8



1090



0 - 13 km/h



Kubota D-902



OPTIONAL
0 - 8,5 km/h



235 cm



Dimensioni:

- Lunghezza: 275 cm
- Larghezza: 92 cm
- Altezza: 225 cm
- Altezza max braccio: 270 cm

*Capacità di sollevamento sotto piastra d'attacco

Ruote:
23x8.5-12

Motore:

Kubota, diesel 3 cilindri raffreddato a liquido

Potenza:
24.8 CV

Cilindrata:
902 cc



Measurements:

- Length: 275 cm (108.27 in)
- Width: 92 cm (36.22 in)
- Height: 225 cm (88.58 in)
- Max arm height: 270 cm (106.30 in)

*Lifting capacity below mounting plate

Wheels:
23x8.5-12

Engine:

Kubota, diesel 3 cylinders, water cooled

Power:
24.8 HP

Displacement:
902 cc



Dimensions:

- Longueur: 275 cm
- Largeur: 92 cm
- Hauteur: 225 cm
- Hauteur max. du bras: 270 cm

*Capacité de levage dessous la plaque de montage

Roues:
23x8.5-12

Moteur:

Kubota, 3-cylindres diesel, refroidi par liquide

Puissance:
24.8 CV

Déplacement:
902 cc



Dimensiones:

- Longitud: 275 cm
- Anchura: 92 cm
- Altura: 225 cm
- Altura máx. del brazo: 270 cm

*Capacidad de elevación por debajo de la placa de montaje

Ruedas:
23x8.5-12

Motor:

Kubota, 3-cilindros diesel, enfriamiento líquido

Potencia:
24.8 CV

Desplazamiento:
902 cc



Abmessungen:

- Länge: 275 cm
- Breite: 92 cm
- Höhe: 225 cm
- Maximale Armhöhe: 270 cm

*Tragfähigkeit unten Montageplatte

Räder:
23x8.5-12

Motor:

Kubota, diesel 3Zylindern, Flüssigkeitsgekühlt

Macht:
24.8 PS

Verdrängung:
902 cc

PZL 1200 M



24.8



1100



0 - 13 km/h



Kubota D-902



OPTIONAL
0 - 8,5 km/h



Dimensioni:

- Lunghezza: 322 cm
- Larghezza: 95 cm
- Altezza: 228 cm

Ruote:

23x8.5-12

Motore:

Kubota, diesel 3 cilindri raffreddato a liquido

Potenza:

24.8 CV

Cilindrata:

902 cc



Measurements:

- Length: 322 cm (126.77 in)
- Width: 95 cm (37.40 in)
- Height: 228 cm (89.76 in)

Wheels:

23x8.5-12

Engine:

Kubota, diesel 3 cylinders, water cooled

Power:

24.8 HP

Displacement:

902 cc



Dimensions:

- Longueur: 322 cm
- Largeur: 95 cm
- Hauteur: 228 cm

Roues:

23x8.5-12

Moteur:

Kubota, 3-cylindres diesel, refroidi par liquide

Puissance:

24.8 CV

Déplacement:

902 cc



Dimensiones:

- Longitud: 322 cm
- Anchura: 95 cm
- Altura: 228 cm

Ruedas:

23x8.5-12

Motor:

Kubota, 3-cilindros diesel, enfriamiento líquido

Potencia:

24.8 CV

Desplazamiento:

902 cc



Abmessungen:

- Länge: 322 cm
- Breite: 95 cm
- Höhe: 228 cm

Räder:

23x8.5-12

Motor:

Kubota, diesel 3Zylindern, Flüssigkeitsgekühlt

Macht:

24.8 PS

Verdrängung:

902 cc

OPTIONAL PZL

PZL 900 ●

PZL 900 T ●

PZL 1200 ●

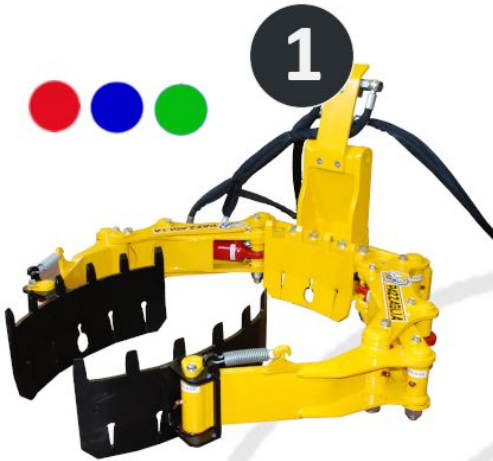

PZ 1 - PINZA IDRAULICA PER VASI Ø DA 30 A 100 CM

- Hydraulic clamp for pots Ø from 30 cm (11.81 in) to 100 cm (39.37 in)
- Pince hydraulique pour pots Ø de 30 cm à 100 cm
- Pinza hidráulica para macetas Ø de 30 cm a 100 cm
- Hydraulische Zange für Töpfe Ø von 30 cm bis 100 cm



PZ 2 - PINZA IDRAULICA PER VASI Ø DA 40 A 120 CM

- Hydraulic clamp for pots Ø from 40 cm (15.75 in) to 120 cm (47.24 in)
- Pince hydraulique pour pots Ø de 40 cm à 120 cm
- Pinza hidráulica para macetas Ø de 40 cm a 120 cm
- Hydraulische Zange für Töpfe Ø von 40 cm bis 120 cm



BENNA DA 96 CM O 125 CM

- Bucket of 96 cm (37.80 in) or 125 cm (49.21 in)
- Godet de 96 cm ou 125 cm
- Cuchara excavadora de 96 cm o 125 cm
- 96 cm Greifer oder 125 cm

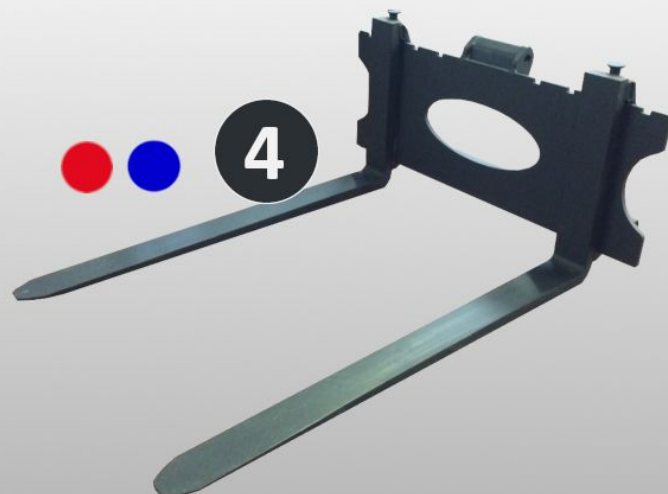

FORCHE

- Forks
- Fourches
- Horquillas
- Gabel

CINGOLI TRIANGOLARI DA 18 CM

- Triangular rubber belt tracks of 18 cm (7.09 in)
- Chenilles triangulaires de 18 cm
- Orugas triangulares en goma de 18 cm
- Dreieckige Gummiketten von 18 cm



PINZA MECCANICA A DENTI

- Mechanic toothed clamp
- Pince mécanique avec dents
- Pinza mecánica con dientes
- Mechanische Zange



POSIZIONATORE PER VASI Ø DA 18 CM A 30 CM

- Container positioner for pots \varnothing from 18 cm (7.07 in) to 30 cm (11.81 in)
- Placeuse de conteneurs \varnothing de 18 cm à 30 cm
- Posicionadora de macetas \varnothing de 18 cm a 30 cm
- Topfsetzer fuer Container \varnothing von 18 cm bis 30 cm

PZ 1200



Lombardini 15 LD315
Honda GX270



	<p>Dimensioni:</p> <ul style="list-style-type: none"> • Lunghezza: 160 cm • Larghezza: 90 cm • Altezza: 120 cm 	<p>Ruote:</p> <p>Anteriori 2x 4.00/8" Posteriore 1x 18x9.50/8"</p>	<p>Motore:</p> <p>Lombardini 15 LD315 (diesel) o Honda GX270 (benzina)</p>	<p>Potenza:</p> <p>6.8 CV / 9 CV</p> <p>Avviamento a strappo</p>
	<p>Measurements:</p> <ul style="list-style-type: none"> • Length: 160 cm (62.99 in) • Width: 90 cm (35.43 in) • Height: 120 cm (47.24 in) 	<p>Wheels:</p> <p>Front 2x 4.00/8" Rear 1x 18x9.50/8"</p>	<p>Engine:</p> <p>Lombardini 15 LD315 (diesel) or Honda GX270 (petrol)</p>	<p>Power:</p> <p>6.8 HP / 9 HP</p> <p>Rope starter</p>
	<p>Dimensions:</p> <ul style="list-style-type: none"> • Longueur: 160 cm • Largeur: 90 cm • Hauteur: 120 cm 	<p>Roues:</p> <p>Avant 2x 4.00/8" Arrière 1x 18x9.50/8"</p>	<p>Moteur:</p> <p>Lombardini 15 LD315 (diesel) ou Honda GX270 (essence)</p>	<p>Puissance:</p> <p>6.8 CV / 9 CV</p> <p>Démarrage par lanceur</p>
	<p>Dimensiones:</p> <ul style="list-style-type: none"> • Longitud: 160 cm • Anchura: 90 cm • Altura: 120 cm 	<p>Ruedas:</p> <p>Frente 2x 4.00/8" Trasero 1x 18x9.50/8"</p>	<p>Motor:</p> <p>Lombardini 15 LD315 (diesel) o Honda GX270 (gasolina)</p>	<p>Potencia:</p> <p>6.8 CV / 9 CV</p> <p>Arranque manual</p>
	<p>Abmessungen:</p> <ul style="list-style-type: none"> • Länge: 160 cm • Breite: 90 cm • Höhe: 120 cm 	<p>Räder:</p> <p>Vorderräder 2x 4.00/8" Hinterräder 1x 18x9.50/8"</p>	<p>Motor:</p> <p>Lombardini 15 LD315 (Diesel) oder Honda GX270 (Benzin)</p>	<p>Macht:</p> <p>6.8 PS / 9 PS</p> <p>Seilzugstarter</p>

CESTE POTATURA

*PRUNING PLATFORMS
PLATEFORMES D'ÉLAGAGE
PLATAFORMAS DE PODA
SCHNEIDEBÜHNEN*



CSP 300



25



1750



Kubota D-1105



0 - 3.5 km/h



 <p>Dimensioni:</p> <ul style="list-style-type: none"> • Lunghezza: 300 cm • Larghezza: Carreggiata fissa 120 cm • Larghezza pedana: 90 cm • Altezza max.: 298 cm 	<p>Ruote: 26x12,00-12</p>	<p>Motore: Kubota, diesel 3 cilindri raffreddato a liquido</p>	<p>Potenza: 25 CV a 3000 giri/min</p> <p>Cilindrata: 1105 cc</p>
 <p>Measurements:</p> <ul style="list-style-type: none"> • Length: 300 cm (118.11 in) • Width: Fixed width of 120 cm (47.24 in) • Platform Width: 90 cm (35.43 in) • Max Height: 298 cm (117.32 in) 	<p>Wheels: 26x12,00-12</p>	<p>Engine: Kubota, diesel 3 cylinders, water cooled</p>	<p>Power: 25 HP at 3000 RPM</p> <p>Displacement: 1105 cc</p>
 <p>Dimensions:</p> <ul style="list-style-type: none"> • Longueur: 300 cm • Largeur: Largeur fixe de 120 cm • Largeur de la plateforme: 90 cm • Hauteur max.: 298 cm 	<p>Roues: 26x12,00-12</p>	<p>Moteur: Kubota, 3-cylindres diesel, refroidi par liquide</p>	<p>Puissance: 25 CV à 3000 TR/MIN</p> <p>Déplacement: 1105 cc</p>
 <p>Dimensiones:</p> <ul style="list-style-type: none"> • Longitud: 300 cm • Anchura: Anchura fija de 120 cm • Ancho de la plataforma: 90 cm • Altura max.: 298 cm 	<p>Ruedas: 26x12,00-12</p>	<p>Motor: Kubota, 3-cilindros diesel, enfriamiento líquido</p>	<p>Potencia: 25 CV a 3000 RPM</p> <p>Desplazamiento: 1105 cc</p>
 <p>Abmessungen:</p> <ul style="list-style-type: none"> • Länge: 300 cm • Breite: Feste Breite 120 cm • Plattformbreite: 90 cm • Höhe: 298 cm 	<p>Räder: 26x12,00-12</p>	<p>Motor: Kubota, diesel 3Zylindern, Flüssigkeitsgekühlt</p>	<p>Macht: 25 PS bei 3000 u/MIN</p> <p>Verdrängung: 1105 cc</p>



25



2100



Kubota D-1105



0 - 3.5 km/h

Dimensioni:

- Lunghezza: 300 cm
- Larghezza: Allargamento idraulico da 90 cm a 160 cm
- Larghezza pedana: Variabile idraulicamente da 90 cm a 150 cm
- Altezza max.: 450 cm



Ruote:

26x12,00-12

Motore:

Kubota, diesel 3 cilindri raffreddato a liquido

Potenza:

25 CV a 3000 giri/min

Cilindrata:

1105 cc

Measurements:

- Length: 300 cm (118.11 in)
- Width: Hydr. adjust. from 90 cm (35.43 in) to 160 cm (62.99 in)
- Platform Width: Hydr. variable from 90 cm (35.43 in) to 150 cm (59.06 in)
- Max Height: 450 cm (177.17 in)



Wheels:

26x12,00-12

Engine:

Kubota, diesel 3 cylinders, water cooled

Power:

25 HP at 3000 RPM

Displacement:

1105 cc

Dimensions:

- Longueur: 300 cm
- Largeur: Élargissement hydraulique de 90 cm à 160 cm
- Largeur de la plateforme: Hydr. variable de 90 cm à 150 cm
- Hauteur max.: 450 cm



Roues:

26x12,00-12

Moteur:

Kubota, 3-cylindres diesel, refroidi par liquide

Puissance:

25 CV à 3000 TR/MIN

Déplacement:

1105 cc

Dimensiones:

- Longitud: 300 cm
- Anchura: Enchance hidráulico de 90 cm a 160 cm
- Ancho de la plataforma: Hidr. variable de 90 cm a 150 cm
- Altura max.: 450 cm



Ruedas:

26x12,00-12

Motor:

Kubota, 3-cilindros diesel, enfriamiento líquido

Potencia:

25 CV a 3000 RPM

Desplazamiento:

1105 cc

Abmessungen:

- Länge: 300 cm
- Breite: Hydraulisch einstellbare Breite von 90 cm bis 160 cm
- Plattformbreite: Hydraulisch variabel von 90 cm bis 150 cm
- Höhe: 450 cm



Räder:

26x12,00-12

Motor:

Kubota, diesel 3Zylindern, Flüssigkeitsgekühlt

Macht:

25 PS bei 3000 u/MIN

Verdrängung:

1105 cc

CSC 300



25



2200



Kubota D-1105



0 - 2.5 km/h



0 - 5 km/h



Dimensioni:

- Lunghezza: 360 cm
- Larghezza: Allargamento idraulico da 107 cm a 175 cm
- Altezza max.: 298 cm

• **OPTIONAL:** Allargamento idraulico pedana da 96 cm a 156 cm

Cingoli:

in gomma da 23 cm

Motore:

Kubota, diesel 3 cilindri raffreddato a liquido

Potenza:

25 CV a 3000 giri/min

Cilindrata:

1105 cc



Measurements:

- Length: 360 cm (141.73 in)
- Width: Hydraulic adjustable width from 107 cm (42.13 in) to 175 cm (68.90 in)
- Max Height: 298 cm (117.32 in)

• **OPTIONAL:** Hydr. platform extension 96-156 cm

Belt tracks:

in rubber of 23 cm (9.06 in)

Engine:

Kubota, diesel 3 cylinders, water cooled

Power:

25 HP at 3000 RPM

Displacement:

1105 cc



Dimensions:

- Longueur: 360 cm
- Largeur: Élargissement hydraulique de 107 cm à 175 cm
- Hauteur max.: 298 cm

• **OPTION:** Extension hydr. de la plateforme 96-156 cm

Chenilles:

en caoutchouc de 23 cm

Moteur:

Kubota, 3-cylindres diesel, refroidi par liquide

Puissance:

25 CV à 3000 TR/MIN

Déplacement:

1105 cc



Dimensiones:

- Longitud: 360 cm
- Anchura: Enhance hidráulico de 107 cm a 175 cm
- Altura max.: 298 cm

• **OPCIONAL:** Extensión hidr. plataforma 96-156 cm

Orugas:

de goma de 23 cm

Motor:

Kubota, 3-cilindros diesel, enfriamiento líquido

Potencia:

25 CV a 3000 RPM

Desplazamiento:

1105 cc



Abmessungen:

- Länge: 360 cm
- Breite: Hydraulisch einstellbare Breite von 107 cm bis 175 cm
- Höhe: 298 cm

• **OPTIONAL:** Hydraulische Verlängerung der Plattform 96-156 cm

Gummiketten:

23 cm

Motor:

Kubota, diesel 3Zylindern, Flüssigkeitsgekühlt

Macht:

25 PS bei 3000 u/MIN

Verdrängung:

1105 cc

CSC 500

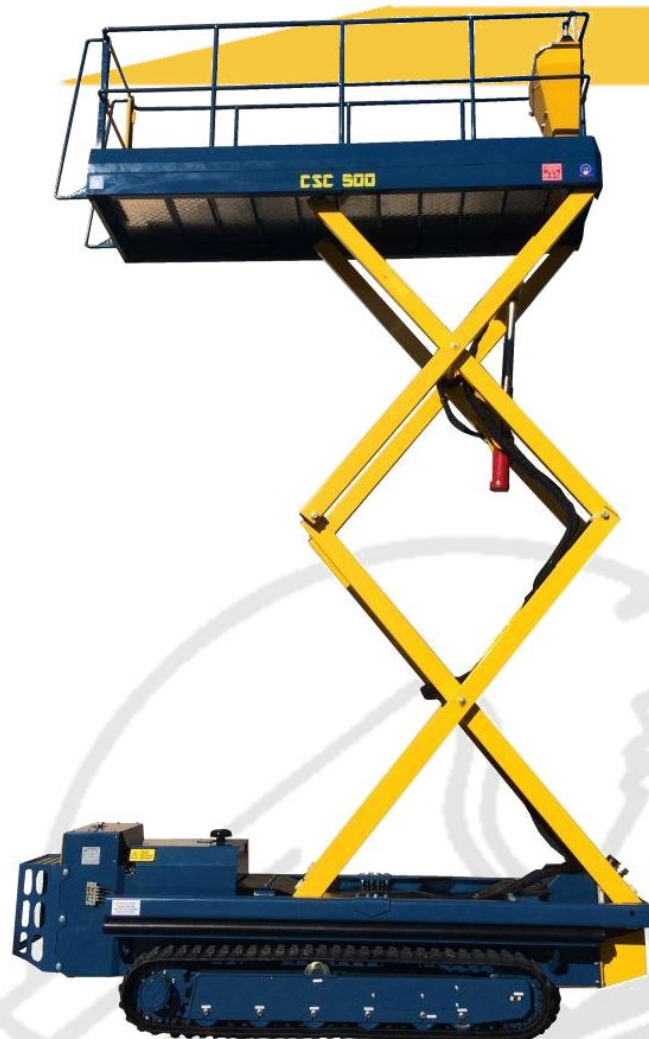

33



2350



Kubota V-1505



0 - 2.5 km/h



0 - 5 km/h

Dimensioni:

- Lunghezza: 360 cm
- Larghezza: Allargamento idraulico da 107 cm a 175 cm
- Altezza max.: 500 cm

• **OPTIONAL:** Allargamento idraulico pedana da 96 cm a 156 cm

Cingoli:

in gomma da 23 cm

Motore:

Kubota, diesel 4 cilindri raffreddato a liquido

Potenza:

33 CV a 3000 giri/min

Cilindrata:

1505 cc



Measurements:

- Length: 360 cm (141.73 in)
- Width: Hydr. adjust. from 107 cm (42.13 in) to 175 cm (68.90 in)
- Max Height: 500 cm (196.85 in)

• **OPTIONAL:** Hydr. platform extension 96-156 cm

Belt tracks:

in rubber of 23 cm (9.06 in)

Engine:

Kubota, diesel 4 cylinders, water cooled

Power:

33 HP at 3000 RPM

Displacement:

1505 cc



Dimensions:

- Longueur: 360 cm
- Largeur: Elargissement hydraulique de 107 cm à 175 cm
- Hauteur max.: 500 cm

• **OPTION:** Extension hydr. de la plateforme 96-156 cm

Chenilles:

en caoutchouc de 23 cm

Moteur:

Kubota, 4-cylindres diesel, refroidi par liquide

Puissance:

33 CV à 3000 TR/MIN

Déplacement:

1505 cc



Dimensiones:

- Longitud: 360 cm
- Anchura: Enhanche hidráulico de 107 cm a 175 cm
- Altura max.: 500 cm

• **OPCIONAL:** Extensión hydr. plataforma 96-156 cm

Orugas:

de goma de 23 cm

Motor:

Kubota, 4-cilindros diesel, enfriamiento líquido

Potencia:

33 CV a 3000 RPM

Desplazamiento:

1505 cc



Abmessungen:

- Länge: 360 cm
- Breite: Hydraulisch einstellbare Breite von 107 cm bis 175 cm
- Höhe: 500 cm

• **OPTIONAL:** Hydraulische Verlängerung der Plattform 96-156 cm

Gummiketten:

23 cm

Motor:

Kubota, diesel 4Zylindern, Flüssigkeitsgekühlt

Macht:

33 PS bei 3000 u/MIN

Verdrängung:

1505 cc





POTATRICI

PRUNERS
TAILLEUSES
PODADORAS
SCHNEIDEMASCHINEN



GP 60



1,3



18



Honda GX35



Ø 25, 30, 35, 40,
45, 50, 55, 60 cm



Dimensioni:

- Lunghezza: 80 cm
- Larghezza: 65 cm
- Altezza: 130 cm

Peso:
18 kg

Motore:

Honda, benzina 4 tempi

Potenza:

1,3 CV a 7000 giri/min

Cilindrata:
35.8 cc



Measurements:

- Length: 80 cm (31.50 in)
- Width: 65 cm (25.59 in)
- Height: 130 cm (51.18 in)

Weight:
18 kg

Engine:

Honda, gasoline 4-stroke

Power:

1.3 HP at 7000 RPM

Displacement:
35.8 cc



Dimensions:

- Longueur: 80 cm
- Largeur: 65 cm
- Hauteur: 130 cm

Poids:
18 kg

Moteur:

Honda, essence 4 temps

Puissance:

1,3 CV à 7000 TR/MIN

Déplacement:
35.8 cc



Dimensiones:

- Longitud: 80 cm
- Anchura: 65 cm
- Altura: 130 cm

Peso:
18 kg

Motor:

Honda, gasolina 4 tiempos

Potencia:

1,3 CV a 7000 RPM

Desplazamiento:
35.8 cc



Abmessungen:

- Länge: 80 cm
- Breite: 65 cm
- Höhe: 130 cm

Größe:
18 kg

Motor:

Honda, benzin 4-Takt

Macht:

1,3 PS bei 7000 u/MIN

Verdrängung:
35.8 cc

GP 80 / GP 80 T



4,4



KG

280



Honda GX200

Ø 25, 30, 35, 40, 45, 50, 55, 60, 65, 70, 75, 80 cm



Dimensioni:

- Lunghezza: 180 cm
- Larghezza: 105 cm
- Altezza min.-max. di lavoro: 0-160 cm
- Altezza tot. macchina: 200 cm

Motore:

Honda, benzina 4 tempi

Potenza:

5,5 CV a 3600 giri/min

Cilindrata:

196 cc



Measurements:

- Length: 180 cm (70.87 in)
- Width: 105 cm (41.34 in)
- Min-Max working height: 0-160 cm (0-62.99 in)
- Tot. machine height: 200 cm (78.74 in)

Engine:

Honda, gasoline 4-stroke

Power:

5.5 HP at 3600 RPM

Displacement:

196 cc



Dimensions:

- Longueur: 180 cm
- Largeur: 105 cm
- Hauteur de travail Min.-Max.: 0-160 cm
- Tot. hauteur de la machine: 200 cm

Moteur:

Honda, essence 4 temps

Puissance:

5,5 CV à 3600 TR/MIN

Déplacement:

196 cc



Dimensiones:

- Longitud: 180 cm
- Anchura: 105 cm
- Altura min.-max. de trabajo: 0-160 cm
- Altura tot. de la maquina: 200 cm

Motor:

Honda, gasolina 4 tiempos

Potencia:

5,5 CV a 3600 RPM

Desplazamiento:

196 cc



Abmessungen:

- Länge: 180 cm
- Breite: 105 cm
- Min. - max. Arbeitshöhe: 0-160 cm
- Gesamthöhe der Maschine: 200 cm

Motor:

Honda, benzin 4-Takt

Macht:

5,5 PS bei 3600 u/MIN

Verdrängung:

196 cc

GP 70 R



5,5



250



Honda GX200



Ø 25, 30, 35, 40,
45, 50, 55, 60,
65, 70, 75, 80 cm







	<p>Dimensioni:</p> <ul style="list-style-type: none"> • Lunghezza: 139,5 cm • Larghezza: 204 cm • Altezza: 232 cm 	<p>Peso: 250 kg</p>	<p>Motore: Honda, benzina 4 tempi</p>	<p>Potenza: 5,5 CV a 3600 giri/min</p> <p>Cilindrata: 196 cc</p>
	<p>Measurements:</p> <ul style="list-style-type: none"> • Length: 139,5 cm (54.92 in) • Width: 204 cm (80.32 in) • Height: 232 cm (91.34 in) 	<p>Weight: 250 kg</p>	<p>Engine: Honda, gasoline 4-stroke</p>	<p>Power: 5.5 HP at 3600 RPM</p> <p>Displacement: 196 cc</p>
	<p>Dimensions:</p> <ul style="list-style-type: none"> • Longueur: 139,5 cm • Largeur: 204 cm • Hauteur: 232 cm 	<p>Poids: 250 kg</p>	<p>Moteur: Honda, essence 4 temps</p>	<p>Puissance: 5,5 CV à 3600 TR/MIN</p> <p>Déplacement: 196 cc</p>
	<p>Dimensiones:</p> <ul style="list-style-type: none"> • Longitud: 139,5 cm • Anchura: 204 cm • Altura: 232 cm 	<p>Peso: 250 kg</p>	<p>Motor: Honda, gasolina 4 tiempos</p>	<p>Potencia: 5,5 CV a 3600 RPM</p> <p>Desplazamiento: 196 cc</p>
	<p>Abmessungen:</p> <ul style="list-style-type: none"> • Länge: 139,5 cm • Breite: 204 cm • Höhe: 232 cm 	<p>Größe: 250 kg</p>	<p>Motor: Honda, benzin 4-Takt</p>	<p>Macht: 5,5 PS bei 3600 u/MIN</p> <p>Verdrängung: 196 cc</p>

CARICATORI

CRANES
GRUES
GRÚAS
KRÄNE









 <p>Potenza trattore: Max. 20 CV 15 kW</p>	<p>Peso min. trattore: 600 kg</p>	<p>Sfilo:</p> <ul style="list-style-type: none"> • Meccanico <input checked="" type="checkbox"/> • Idraulico <input type="checkbox"/> • Doppio sfilo <input type="checkbox"/> 	<p>Rotazione:</p> <ul style="list-style-type: none"> • Fisso <input checked="" type="checkbox"/> • Girevole 90° <input type="checkbox"/> • Girevole 180° <input type="checkbox"/>
 <p>Tractor power: Max. 20 HP 15 kW</p>	<p>Tractor min. weight: 600 kg</p>	<p>Extension:</p> <ul style="list-style-type: none"> • Mechanic <input checked="" type="checkbox"/> • Hydraulic <input type="checkbox"/> • Double extension <input type="checkbox"/> 	<p>Rotation:</p> <ul style="list-style-type: none"> • Fix <input checked="" type="checkbox"/> • 90° Swivel <input type="checkbox"/> • 180° Swivel <input type="checkbox"/>
 <p>Puissance du tracteur: Max. 20 CV 15 kW</p>	<p>Poids min. du tracteur: 600 kg</p>	<p>Extension:</p> <ul style="list-style-type: none"> • Mécanique <input checked="" type="checkbox"/> • Hydraulique <input type="checkbox"/> • Double extension <input type="checkbox"/> 	<p>Rotation:</p> <ul style="list-style-type: none"> • Fixe <input checked="" type="checkbox"/> • Pivotant à 90° <input type="checkbox"/> • Pivotant à 180° <input type="checkbox"/>
 <p>Potencia del tractor: Max. 20 CV 15 kW</p>	<p>Peso mín. del tractor: 600 kg</p>	<p>Extensión:</p> <ul style="list-style-type: none"> • Mecánica <input checked="" type="checkbox"/> • Hidráulica <input type="checkbox"/> • Doble extensión <input type="checkbox"/> 	<p>Rotación:</p> <ul style="list-style-type: none"> • Fijo <input checked="" type="checkbox"/> • Giratorio 90° <input type="checkbox"/> • Giratorio 180° <input type="checkbox"/>
 <p>Traktorleistung: Max. 20 PS 15 kW</p>	<p>Mindestgewicht des Traktors: 600 kg</p>	<p>Ausdehnung:</p> <ul style="list-style-type: none"> • Mechanisch <input checked="" type="checkbox"/> • Hydraulisch <input type="checkbox"/> • Doppelausdehnung <input type="checkbox"/> 	<p>Drehung:</p> <ul style="list-style-type: none"> • Fest <input checked="" type="checkbox"/> • Drehbar 90° <input type="checkbox"/> • Drehbar 180° <input type="checkbox"/>







	Potenza trattore: 25 - 40 CV 18.4 - 29.4 kW	Peso min. trattore: 1200 kg	Sfilo: <ul style="list-style-type: none"> • Meccanico ✓ • Idraulico ✓ • Doppio sfilo ✗ 	Rotazione: <ul style="list-style-type: none"> • Fisso ✓ • Girevole 90° ✓ • Girevole 180° ✗
	Tractor power: 25 - 40 HP 18.4 - 29.4 kW	Tractor min. weight: 1200 kg	Extension: <ul style="list-style-type: none"> • Mechanic ✓ • Hydraulic ✓ • Double extension ✗ 	Rotation: <ul style="list-style-type: none"> • Fix ✓ • 90° Swivel ✓ • 180° Swivel ✗
	Puissance du tracteur: 25 - 40 CV 18.4 - 29.4 kW	Poids min. du tracteur: 1200 kg	Extension: <ul style="list-style-type: none"> • Mécanique ✓ • Hydraulique ✓ • Double extension ✗ 	Rotation: <ul style="list-style-type: none"> • Fixe ✓ • Pivotant à 90° ✓ • Pivotant à 180° ✗
	Potencia del tractor: 25 - 40 CV 18.4 - 29.4 kW	Peso mín. del tractor: 1200 kg	Extensión: <ul style="list-style-type: none"> • Mecánica ✓ • Hidráulica ✓ • Doble extensión ✗ 	Rotación: <ul style="list-style-type: none"> • Fijo ✓ • Giratorio 90° ✓ • Giratorio 180° ✗
	Traktorleistung: 25 - 40 PS 18.4 - 29.4 kW	Mindestgewicht des Traktors: 1200 kg	Ausdehnung: <ul style="list-style-type: none"> • Mechanisch ✓ • Hydraulisch ✓ • Doppelausdehnung ✗ 	Drehung: <ul style="list-style-type: none"> • Fest ✓ • Drehbar 90° ✓ • Drehbar 180° ✗

SP 4



 <p>Potenza trattore: 25 - 60 CV 18.4 - 44.1 kW</p>	<p>Peso min. trattore: 1700 kg</p>	<p>Sfilo:</p> <ul style="list-style-type: none"> • Meccanico ✓ • Idraulico ✓ • Doppio sfilo ✗ 	<p>Rotazione:</p> <ul style="list-style-type: none"> • Fisso ✓ • Girevole 90° ✓ • Girevole 180° ✓
 <p>Tractor power: 25 - 60 HP 18.4 - 44.1 kW</p>	<p>Tractor min. weight: 1700 kg</p>	<p>Extension:</p> <ul style="list-style-type: none"> • Mechanic ✓ • Hydraulic ✓ • Double extension ✗ 	<p>Rotation:</p> <ul style="list-style-type: none"> • Fix ✓ • 90° Swivel ✓ • 180° Swivel ✓
 <p>Puissance du tracteur: 25 - 60 CV 18.4 - 44.1 kW</p>	<p>Poids min. du tracteur: 1700 kg</p>	<p>Extension:</p> <ul style="list-style-type: none"> • Mécanique ✓ • Hydraulique ✓ • Double extension ✗ 	<p>Rotation:</p> <ul style="list-style-type: none"> • Fixe ✓ • Pivotant à 90° ✓ • Pivotant à 180° ✓
 <p>Potencia del tractor: 25 - 60 CV 18.4 - 44.1 kW</p>	<p>Peso mín. del tractor: 1700 kg</p>	<p>Extensión:</p> <ul style="list-style-type: none"> • Mecánica ✓ • Hidráulica ✓ • Doble extensión ✗ 	<p>Rotación:</p> <ul style="list-style-type: none"> • Fijo ✓ • Giratorio 90° ✓ • Giratorio 180° ✓
 <p>Traktorleistung: 25 - 60 PS 18.4 - 44.1 kW</p>	<p>Mindestgewicht des Traktors: 1700 kg</p>	<p>Ausdehnung:</p> <ul style="list-style-type: none"> • Mechanisch ✓ • Hydraulisch ✓ • Doppelausdehnung ✗ 	<p>Drehung:</p> <ul style="list-style-type: none"> • Fest ✓ • Drehbar 90° ✓ • Drehbar 180° ✓



	Potenza trattore: 50 - 90 CV 36.8 - 66.2 kW	Peso min. trattore: 1800 kg	Sfilo: <ul style="list-style-type: none"> • Meccanico ✗ • Idraulico ✓ • Doppio sfilo ✓ 	Rotazione: <ul style="list-style-type: none"> • Fisso ✓ • Girevole 90° ✓ • Girevole 180° ✓
	Tractor power: 50 - 90 HP 36.8 - 66.2 kW	Tractor min. weight: 1800 kg	Extension: <ul style="list-style-type: none"> • Mechanic ✗ • Hydraulic ✓ • Double extension ✓ 	Rotation: <ul style="list-style-type: none"> • Fix ✓ • 90° Swivel ✓ • 180° Swivel ✓
	Puissance du tracteur: 50 - 90 CV 36.8 - 66.2 kW	Poids min. du tracteur: 1800 kg	Extension: <ul style="list-style-type: none"> • Mécanique ✗ • Hydraulique ✓ • Double extension ✓ 	Rotation: <ul style="list-style-type: none"> • Fixe ✓ • Pivotant à 90° ✓ • Pivotant à 180° ✓
	Potencia del tractor: 50 - 90 CV 36.8 - 66.2 kW	Peso mín. del tractor: 1800 kg	Extensión: <ul style="list-style-type: none"> • Mecánica ✗ • Hidráulica ✓ • Doble extensión ✓ 	Rotación: <ul style="list-style-type: none"> • Fijo ✓ • Giratorio 90° ✓ • Giratorio 180° ✓
	Traktorleistung: 50 - 90 PS 36.8 - 66.2 kW	Mindestgewicht des Traktors: 1800 kg	Ausdehnung: <ul style="list-style-type: none"> • Mechanisch ✗ • Hydraulisch ✓ • Doppelausdehnung ✓ 	Drehung: <ul style="list-style-type: none"> • Fest ✓ • Drehbar 90° ✓ • Drehbar 180° ✓







	Potenza trattore: 30 - 70 CV 22.1 - 51.5 kW	Peso min. trattore: 1700 kg	Sfilo: <ul style="list-style-type: none"> • Meccanico ✓ • Idraulico ✓ • Doppio sfilo ✓ 	Rotazione: <ul style="list-style-type: none"> • Fisso ✓ • Girevole 90° ✓ • Girevole 180° ✓
	Tractor power: 30 - 70 HP 22.1 - 51.5 kW	Tractor min. weight: 1700 kg	Extension: <ul style="list-style-type: none"> • Mechanic ✓ • Hydraulic ✓ • Double extension ✓ 	Rotation: <ul style="list-style-type: none"> • Fix ✓ • 90° Swivel ✓ • 180° Swivel ✓
	Puissance du tracteur: 30 - 70 CV 22.1 - 51.5 kW	Poids min. du tracteur: 1700 kg	Extension: <ul style="list-style-type: none"> • Mécanique ✓ • Hydraulique ✓ • Double extension ✓ 	Rotation: <ul style="list-style-type: none"> • Fixe ✓ • Pivotant à 90° ✓ • Pivotant à 180° ✓
	Potencia del tractor: 30 - 70 CV 22.1 - 51.5 kW	Peso mín. del tractor: 1700 kg	Extensión: <ul style="list-style-type: none"> • Mecánica ✓ • Hidráulica ✓ • Doble extensión ✓ 	Rotación: <ul style="list-style-type: none"> • Fijo ✓ • Giratorio 90° ✓ • Giratorio 180° ✓
	Traktorleistung: 30 - 70 PS 22.1 - 51.5 kW	Mindestgewicht des Traktors: 1700 kg	Ausdehnung: <ul style="list-style-type: none"> • Mechanisch ✓ • Hydraulisch ✓ • Doppelausdehnung ✓ 	Drehung: <ul style="list-style-type: none"> • Fest ✓ • Drehbar 90° ✓ • Drehbar 180° ✓







	Potenza trattore: 60 - 120 CV 44.1 - 88.3 kW	Peso min. trattore: 2200 kg	Sfilo: <ul style="list-style-type: none"> • Meccanico ✗ • Idraulico ✓ • Doppio sfilo ✓ 	Rotazione: <ul style="list-style-type: none"> • Fisso ✓ • Girevole 90° ✓ • Girevole 180° ✓
	Tractor power: 60 - 120 HP 44.1 - 88.3 kW	Tractor min. weight: 2200 kg	Extension: <ul style="list-style-type: none"> • Mechanic ✗ • Hydraulic ✓ • Double extension ✓ 	Rotation: <ul style="list-style-type: none"> • Fix ✓ • 90° Swivel ✓ • 180° Swivel ✓
	Puissance du tracteur: 60 - 120 CV 44.1 - 88.3 kW	Poids min. du tracteur: 2200 kg	Extension: <ul style="list-style-type: none"> • Mécanique ✗ • Hydraulique ✓ • Double extension ✓ 	Rotation: <ul style="list-style-type: none"> • Fixe ✓ • Pivotant à 90° ✓ • Pivotant à 180° ✓
	Potencia del tractor: 60 - 120 CV 44.1 - 88.3 kW	Peso mín. del tractor: 2200 kg	Extensión: <ul style="list-style-type: none"> • Mecánica ✗ • Hidráulica ✓ • Doble extensión ✓ 	Rotación: <ul style="list-style-type: none"> • Fijo ✓ • Giratorio 90° ✓ • Giratorio 180° ✓
	Traktorleistung: 60 - 120 PS 44.1 - 88.3 kW	Mindestgewicht des Traktors: 2200 kg	Ausdehnung: <ul style="list-style-type: none"> • Mechanisch ✗ • Hydraulisch ✓ • Doppelausdehnung ✓ 	Drehung: <ul style="list-style-type: none"> • Fest ✓ • Drehbar 90° ✓ • Drehbar 180° ✓

SP 9







 <p>Potenza trattore: 120 CV 88.3 kW</p>	<p>Peso min. trattore: 4500 kg</p>	<p>Sfilo:</p> <ul style="list-style-type: none"> • Meccanico ✗ • Idraulico ✓ • Doppio sfilo ✓ 	<p>Rotazione:</p> <ul style="list-style-type: none"> • Fisso ✗ • Girevole 90° ✗ • Girevole 180° ✓
 <p>Tractor power: 120 HP 88.3 kW</p>	<p>Tractor min. weight: 4500 kg</p>	<p>Extension:</p> <ul style="list-style-type: none"> • Mechanic ✗ • Hydraulic ✓ • Double extension ✓ 	<p>Rotation:</p> <ul style="list-style-type: none"> • Fix ✗ • 90° Swivel ✗ • 180° Swivel ✓
 <p>Puissance du tracteur: 120 CV 88.3 kW</p>	<p>Poids min. du tracteur: 4500 kg</p>	<p>Extension:</p> <ul style="list-style-type: none"> • Mécanique ✗ • Hydraulique ✓ • Double extension ✓ 	<p>Rotation:</p> <ul style="list-style-type: none"> • Fixe ✗ • Pivotant à 90° ✗ • Pivotant à 180° ✓
 <p>Potencia del tractor: 120 CV 88.3 kW</p>	<p>Peso mín. del tractor: 4500 kg</p>	<p>Extensión:</p> <ul style="list-style-type: none"> • Mecánica ✗ • Hidráulica ✓ • Doble extensión ✓ 	<p>Rotación:</p> <ul style="list-style-type: none"> • Fijo ✗ • Giratorio 90° ✗ • Giratorio 180° ✓
 <p>Traktorleistung: 120 PS 88.3 kW</p>	<p>Mindestgewicht des Traktors: 4500 kg</p>	<p>Ausdehnung:</p> <ul style="list-style-type: none"> • Mechanisch ✗ • Hydraulisch ✓ • Doppelausdehnung ✓ 	<p>Drehung:</p> <ul style="list-style-type: none"> • Fest ✗ • Drehbar 90° ✗ • Drehbar 180° ✓



 <p>Potenza trattore: 60 - 90 CV 44.1 - 66.2 kW</p>	<p>Peso min. trattore: 2500 kg</p>	<p>Sfilo:</p> <ul style="list-style-type: none"> • Meccanico ✗ • Idraulico ✓ • Doppio sfilo ✗ 	<p>Rotazione:</p> <ul style="list-style-type: none"> • Fisso ✓ • Girevole 90° ✗ • Girevole 180° ✗
 <p>Tractor power: 60 - 90 HP 44.1 - 66.2 kW</p>	<p>Tractor min. weight: 2500 kg</p>	<p>Extension:</p> <ul style="list-style-type: none"> • Mechanic ✗ • Hydraulic ✓ • Double extension ✗ 	<p>Rotation:</p> <ul style="list-style-type: none"> • Fix ✓ • 90° Swivel ✗ • 180° Swivel ✗
 <p>Puissance du tracteur: 60 - 90 CV 44.1 - 66.2 kW</p>	<p>Poids min. du tracteur: 2500 kg</p>	<p>Extension:</p> <ul style="list-style-type: none"> • Mécanique ✗ • Hydraulique ✓ • Double extension ✗ 	<p>Rotation:</p> <ul style="list-style-type: none"> • Fixe ✓ • Pivotant à 90° ✗ • Pivotant à 180° ✗
 <p>Potencia del tractor: 60 - 90 CV 44.1 - 66.2 kW</p>	<p>Peso mín. del tractor: 2500 kg</p>	<p>Extensión:</p> <ul style="list-style-type: none"> • Mecánica ✗ • Hidráulica ✓ • Doble extensión ✗ 	<p>Rotación:</p> <ul style="list-style-type: none"> • Fijo ✓ • Giratorio 90° ✗ • Giratorio 180° ✗
 <p>Traktorleistung: 60 - 90 PS 44.1 - 66.2 kW</p>	<p>Mindestgewicht des Traktors: 2500 kg</p>	<p>Ausdehnung:</p> <ul style="list-style-type: none"> • Mechanisch ✗ • Hydraulisch ✓ • Doppelausdehnung ✗ 	<p>Drehung:</p> <ul style="list-style-type: none"> • Fest ✓ • Drehbar 90° ✗ • Drehbar 180° ✗

SP 3 / SP 3 A



 <p>Potenza trattore: 80-120 / 100-160 CV 58.8-88.3 / 73.6-117.7 kW</p>	<p>Peso min. trattore: 4000 kg / 5000 kg</p>	<p>Sfilo:</p> <ul style="list-style-type: none"> • Meccanico ✗ • Idraulico ✓ • Doppio sfilo ✓ 	<p>Rotazione:</p> <ul style="list-style-type: none"> • Fisso ✓ • Girevole 90° ✗ • Girevole 180° ✗
 <p>Tractor power: 80-120 / 100-160 HP 58.8-88.3 / 73.6-117.7 kW</p>	<p>Tractor min. weight: 4000 kg / 5000 kg</p>	<p>Extension:</p> <ul style="list-style-type: none"> • Mechanic ✗ • Hydraulic ✓ • Double extension ✓ 	<p>Rotation:</p> <ul style="list-style-type: none"> • Fix ✓ • 90° Swivel ✗ • 180° Swivel ✗
 <p>Puissance du tracteur: 80-120 / 100-160 CV 58.8-88.3 / 73.6-117.7 kW</p>	<p>Poids min. du tracteur: 4000 kg / 5000 kg</p>	<p>Extension:</p> <ul style="list-style-type: none"> • Mécanique ✗ • Hydraulique ✓ • Double extension ✓ 	<p>Rotation:</p> <ul style="list-style-type: none"> • Fixe ✓ • Pivotant à 90° ✗ • Pivotant à 180° ✗
 <p>Potencia del tractor: 80-120 / 100-160 CV 58.8-88.3 / 73.6-117.7 kW</p>	<p>Peso mín. del tractor: 4000 kg / 5000 kg</p>	<p>Extensión:</p> <ul style="list-style-type: none"> • Mecánica ✗ • Hidráulica ✓ • Doble extensión ✓ 	<p>Rotación:</p> <ul style="list-style-type: none"> • Fijo ✓ • Giratorio 90° ✗ • Giratorio 180° ✗
 <p>Traktorleistung: 80-120 / 100-160 PS 58.8-88.3 / 73.6-117.7 kW</p>	<p>Mindestgewicht des Traktors: 4000 kg / 5000 kg</p>	<p>Ausdehnung:</p> <ul style="list-style-type: none"> • Mechanisch ✗ • Hydraulisch ✓ • Doppelausdehnung ✓ 	<p>Drehung:</p> <ul style="list-style-type: none"> • Fest ✓ • Drehbar 90° ✗ • Drehbar 180° ✗

TRAPIANTATRICI

TREEPLANTERS
PLANTEUSES
PLANTADORAS
VERPFLANZER



PL 6-10



Potenza trattore:
20-25 CV
14.7-18.4 kW

Min-Max Ø zolle:
6-10 cm

Profondità lavoro:
10 cm



Tractor power:
20-25 HP
14.7-18.4 kW

Min-Max Ø rootballs:
6-10 cm (2.36-3.94 in)

Working depth:
10 cm (3.94 in)



Puissance du tracteur:
20-25 CV
14.7-18.4 kW

Min-Max Ø des mottes:
6-10 cm

Profondeur de travail:
10 cm



Potencia del tractor:
20-25 CV
14.7-18.4 kW

Min-Max Ø cepellones:
6-10 cm

Profundidad de trabajo:
10 cm



Traktorleistung:
20-25 PS
14.7-18.4 kW

Min-Max Ø ballen:
6-10 cm

Arbeitstiefe:
10 cm



Potenza trattore:
40 CV
29.4 kW

Min-Max Ø zolle:
10-25 cm

Profondità lavoro:
20 cm



Tractor power:
40 HP
29.4 kW

Min-Max Ø rootballs:
10-25 cm (3.94-9.84 in)

Working depth:
20 cm (7.87 in)



Puissance du tracteur:
40 CV
29.4 kW

Min-Max Ø des mottes:
10-25 cm

Profondeur de travail:
20 cm



Potencia del tractor:
40 CV
29.4 kW

Min-Max Ø cepellones:
10-25 cm

Profundidad de trabajo:
20 cm



Traktorleistung:
40 PS
29.4 kW

Min-Max Ø ballen:
10-25 cm

Arbeitstiefe:
20 cm

PL 15-40



	Potenza trattore: 60 CV 44.1 kW	Min-Max Ø zolle: 15-40 cm	Profondità lavoro: 34 cm
	Tractor power: 60 HP 44.1 kW	Min-Max Ø rootballs: 15-40 cm (5.91-15.75 in)	Working depth: 34 cm (13.39 in)
	Puissance du tracteur: 60 CV 44.1 kW	Min-Max Ø des mottes: 15-40 cm	Profondeur de travail: 34 cm
	Potencia del tractor: 60 CV 44.1 kW	Min-Max Ø cepellones: 15-40 cm	Profundidad de trabajo: 34 cm
	Traktorleistung: 60 PS 44.1 kW	Min-Max Ø ballen: 15-40 cm	Arbeitstiefe: 34 cm

SIRIO 4x4



SIRIO 4x4



Lombardini LDW 702



16



435



↑
I 1,5 km/h
II 3,02 km/h
III 6,07 km/h
IV 12,2 km/h

↓
I R 2,82 km/h
II R 5,68 km/h



Potenza trattore:

16 CV
11.8 kW

Trazione 4x4 con idroguida

Equipaggiamento di serie:

- attacco a 2 punti
- prese idrauliche posteriori



Tractor power:

16 HP
11.8 kW

4 WD with hydraulic steering

Standard equipment:

- 2-points hydraulic plug
- rear hydraulic connections



Puissance du tracteur:

16 CV
11.8 kW

Traction 4x4 avec direction assistée

Équipement standard:

- prise hydraulique à -2 points
- raccords hydrauliques arrière



Potencia del tractor:

16 CV
11.8 kW

Tracción 4x4 con dirección asistida

Equipamiento estandar:

- enchufe hidráulico de -2 puntos
- conexiones hidráulicas traseras



Traktorleistung:

16 PS
11.8 kW

Antrieb 4x4 mit Servolenkung

Ausrüstung:

- 2-Punkte Kupplung
- Hinterwasserkupplungen



SP 8

SOLLEVATORE POSTERIORE

- Rear Crane
- Grue arrière
- Grua trasera
- Hinterer Kran

ERPICE ROTANTE 60 cm

- Rotary harrow 60 cm (23.6 in)
- Herse rotatif 60 cm
- Grada giratoria 60 cm
- Drehegge 60 cm



SPANDICONCIME 60 lt

- Fertilizer 60 lt (16 gal)
- Épandeur d'engrais 60 Lt
- Esparcador de abono 60 lt
- Düngerstreuer 60 Lt

BOTTE DISERBO 120 lt

- Weed sprayer 120 lt (32 gal)
- Tonneau pour herbicides 120 Lt
- Barril para herbicidas 120 lt
- Herbizidenfass 120 Lt



AR2P ASSOLCATORE ROTATIVO

- Rotary trencher
- Coute rotatif
- Asurcador giratorio
- BeetStriegel

OPTIONAL SIRIO 4x4

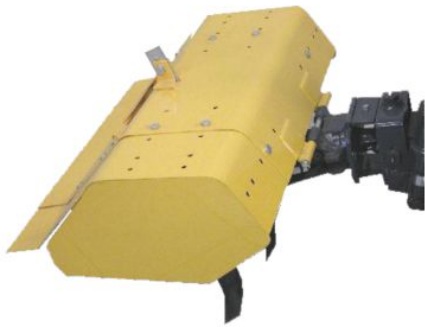

FRESA 60-80 CM

- Rotary tiller 60-80 cm (23.6-31.5 in)
- Fraiseuse 60-80 cm
- Fresadora 60-80 cm
- Fräse 60-80 cm

ESTIRPATORE 5-7 ANCORE

- 5-7 Anchors tiller
- Arracheuse 5-7 ancrés
- Extirpador 5-7 anclas
- Pflugsohler 5-7 Anker



ASSOLCATORE REGISTRABILE

- Adjustable ridger
- Enfouisseur réglable
- Escardadora ajustable
- Einstellbarer Tiefenlockerer

ARATRO

- Plow
- Charrue
- Arado
- Pflug



TRINCIAERBA

- Flail mower
- Coupeuse d'herbe
- Corta hierbas
- Grasschneider

ALTRE MACCHINE

*OTHER MACHINES
AUTRES MACHINES
OTRAS MAQUINAS
ANDERE MASCHINEN*



AR3P

ASSOLCATORE ROTATIVO
ROTARY TRENCHER
COUTRE ROTATIF
ASURCADOR GIRATORIO
BEETSTRIEGEL

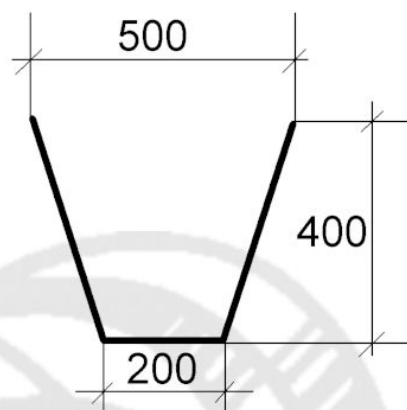

Potenza trattore:
20-50 CV
14.7-36.8 kW



Tractor power:
20-50 HP
14.7-36.8 kW



Puissance du tracteur:
20-50 CV
14.7-36.8 kW



Potencia del tractor:
20-50 CV
14.7-36.8 kW



Traktorleistung:
20-50 PS
14.7-36.8 kW



Pinza idraulica per trasporto vasi da Ø 50 cm a 150 cm



Hydraulic clamp for pots from Ø 50 cm (19.7 in) to 150 cm (50.1 in)



Pince hydraulique pour pots de Ø 50 cm à 150 cm



Pinza hidráulica para macetas de Ø 50 cm a 150 cm.



Hydraulische Zange für Töpfe von 50 bis 150 cm

