

# Fresh, frozen or processed.

We've got the solutions.



## **Poultry**

Innovative packaging and processing solutions for your poultry production.

From MULTIVAC.

**MULTIVAC**

2



# Poultry.

The poultry processing industry is facing major challenges: While labor costs have risen sharply, retail food prices remain fairly constant, which companies have to make up for through higher productivity. One approach to solving this is the ever-increasing automation of production and packaging lines.

This not only makes the entire process faster and more cost-effective, but also more hygienic, more reliable and safer. It also adapts flexibly to new packaging, especially environmentally friendly packaging. These are already very much on trend among consumers. Even before the mandatory EU regulation from 2030.







Innovative machines and materials ensure more sustainability and functionality – and ideally in fully integrated and digitalized lines.

A variety of individual solutions are perfectly coordinated via different communication processes, while collecting and processing valuable information. All within the framework of an industrial IIOT – your Industry 4.0 gateway.

Let's take this journey together.  
Successfully!

# Packaging.

**6** MULTIVAC has been supporting food manufacturers for 60 years with a wide range of innovative and cost-effective packaging solutions. We continuously strive to be your number one partner for the hygienic and sustainable processing and packaging of a wide range of fresh, frozen and processed poultry products. With expertise from a single source: both for complete lines and for automation.

MULTIVAC is investing significantly in sustainable packaging concepts that enable less waste and better use of resources. Our customers worldwide see us as a partner who makes a decisive contribution to their success. Producers benefit greatly from our solutions, which guarantee them maximum productivity and hygiene, while extending the shelf life of the packaged product.



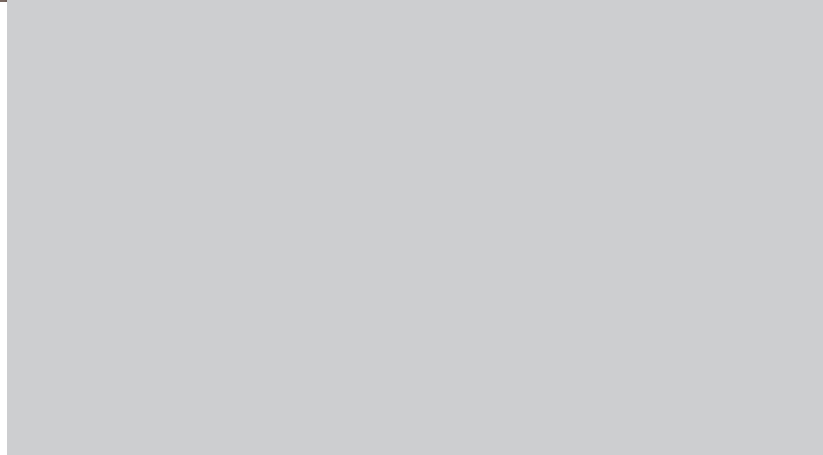
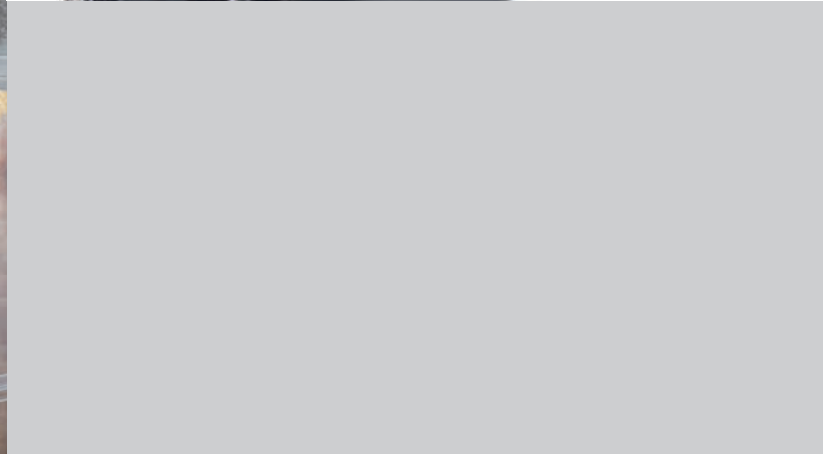
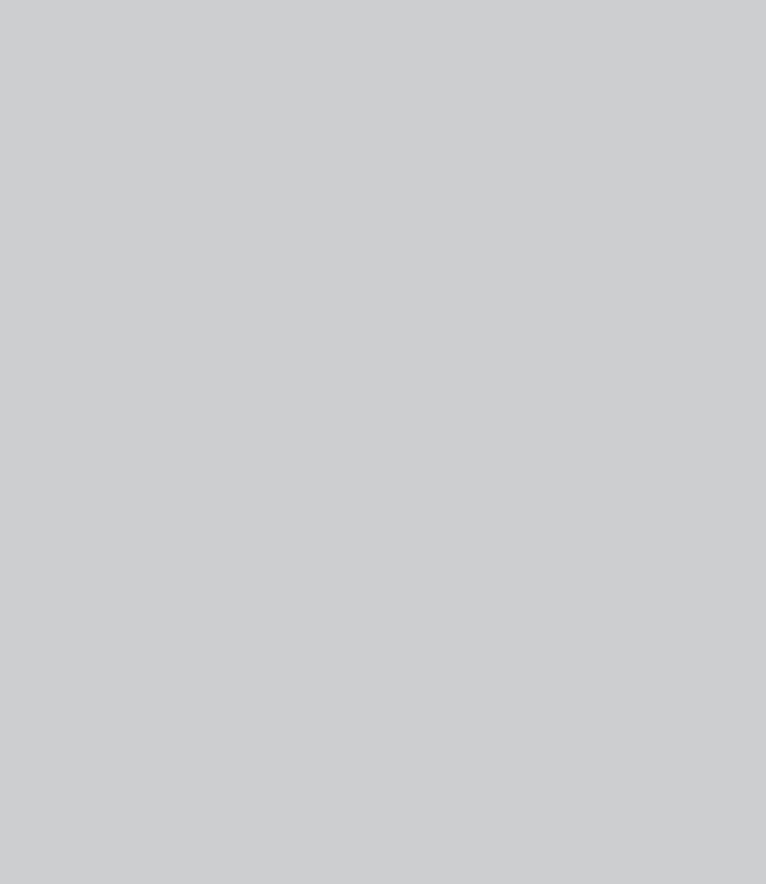

# This is what real partnership looks like.

**8** MULTIVAC's solution expertise is as ecologically sustainable as it is economically viable over the long term. Our portfolio of products, lines and services ensures maximum energy efficiency and productivity – over your line's entire lifecycle. With us, you'll be working with industry experts who understand your segment with all its specific standards and regulations. Entirely focused on your offering and your target groups, our partnership often begins with application and packaging advice, as well as training at our TIC and TAC Technology Centers.

With this solid foundation, virtually unlimited possibilities become available to you: an extensive variety of packaging technologies, Industry 4.0-compatible automation solutions, as well as labelling and quality control systems. Digitalized with real-time analysis tools such as MULTIVAC Smart Services, we can ensure maximum operating and process reliability and line efficiency – right from the word go. So that you get the most from your production equipment and can amortize your investment within a very short time. Thanks to low Total Cost of Ownership (TCO) and energy costs.

Another significant advantage is that, with MULTIVAC, high line availability can be planned over the long run. In terms of Overall Equipment Effectiveness (OEE), we support you with our CustomCare After Sales Solutions – ranging from preventive maintenance agreements (PMAs) and extended warranties to optimization audits, spare parts supply and retrofits, express repairs and deliveries, as well as targeted upgrading measures and the myMULTIVAC customer portal. Our sales and service organization can be quickly on site virtually anywhere around the world or just a simple click away via Live Support on your smartphone and tablet.





# The MULTIVAC PEAQ Promise.

Just as important as TCO and OEE is the actual number of packages you produce. In other words, productivity.

And that's what our **PEAQ Promise** is all about:  
**Productivity, Efficiency, Availability and Quality.**

We continuously provide you with innovative technologies and services to help you increase productivity while minimizing lifecycle costs. Whether you're a small producer for whom flexibility and fast production changeovers are key, or a high-volume industrial manufacturer who demands maximum availability and near-zero downtime risk.



**PEAQ**  
**PROMISE**

Maximize your productivity.

Our **PEAQ**  
PEAQ Promise:  
For your best  
productivity.

# Perfectly matched to your products and customers.

**10** Industry expertise and decades of experience make us the partner of choice when it comes to finding optimal solutions for your poultry products. Solutions that help you increase the reliability of your application, reduce its downtime, lower operating costs and minimize give-away.

Our concepts are individually optimized to meet the requirements of your specific product and target market. The focus here is always on the goal of protecting the freshness and quality of your offering, while using the most sustainable packaging materials possible. So that you remain competitive today and in the future.





# Best in class with innovative packaging solutions.

**12** MULTIVAC offers a wide range of solutions for processing and packaging poultry products of all kinds – hygienically, with a long shelf life, safely and sustainably.

A wide variety of vacuum packs can be produced on our lines: from large packs for commercial users to classic retail packs and MultiCook™ packs for maximum consumer convenience and product quality.

Whether you would like to innovatively present new products or are looking for alternatives to inefficient solutions, we have the right answer for you.

You too can benefit from:

- Safer and more hygienic processes
- Longer shelf life
- Significantly lower packaging costs
- More sustainability



	Instore Overwrap	Masterbag Overwrap	MAP Tray	Vacuum Pack
Hygiene, product safety	★	★★★	★★★★★	★★★★★
Shelf life	★	★★★	★★★★★	★★★★★
Packaging costs	★★	★	★★★	★★★★★
Sustainability	★★	★	★★★	★★★★★



# Solutions.

**14** Our experienced packaging technicians, packaging material experts and food technologists develop customized packaging solutions that are perfectly tailored to your requirements. Safe. Reliable. Hygienic. Ecologically sound and cost-effective. They take into account the special requirements of your products in terms of product protection and shelf life – as well as sustainability criteria and current consumer trends.

## **Vacuum packs**

Packaging under vacuum enables longer product shelf lives, since their biochemical deterioration can be slowed down by removing the air surrounding them. Because the products are compressed in the process, vacuum packs made of flexible film are only suitable for non-pressure-sensitive foods. With vacuum packs, it is also possible to fill and pack hot products. Here the vacuum is created by a special steam purging process which also contributes to a long shelf life.



Vacuum packs



MultiFresh™  
MultiSkin™

## Skin packs

### MultiFresh™

In MultiFresh™ vacuum skin packaging, special skin films are used to enclose the product without tension – like a second skin – and seal it over the entire surface with the bottom film, tray or flatboard. To activate the film properties, the top film passes through a heating station and is then pre-stretched in the sealing tool.

### MultiSkin™

In the MultiSkin™ process, the top film encloses the product skin-tight and is sealed to the bottom film, tray or flatboard via a perimeter sealing.

## Shrink packs

### FormShrink

Special, extremely shrinkable thermoforming films are used in the FormShrink process. The finished pack passes through a shrink unit. The shrinkage of the film is activated by the application of heat from hot water, allowing the film to form a tight seal with the product.

## Modified Atmosphere Packs

### Modified Atmosphere Packaging (MAP)

In modified atmosphere packs, the air in the pack is replaced by a mixture of gases tailored to the product to preserve its shape, color and freshness. The modified atmosphere usually consists of a mixture of carbon dioxide and nitrogen.



FormShrink



Modified Atmosphere Packs





# Taking responsibility for the future: With more sustainable packaging.

MULTIVAC has a wide range of solutions to actively support you and your customers in operating sustainably:

## **Paper-based packaging**

MULTIVAC PaperBoard reduces plastic consumption and increases recyclability.



## **Compostable packaging**

Biobased and biodegradable materials help solve waste problems naturally.

## **Recyclable plastics**

Mono-materials can be sorted and fed into material recycling and reused.



# Paper-based packaging solutions.

**18** With MULTIVAC PaperBoard, we support you in increasing the recyclability of your packaging concepts and reducing plastic consumption in pack production by up to 85%.



By using functional layers, paper-based packs can be developed that meet all the requirements for specific barrier properties, tailored to the respective products.

MULTIVAC PaperBoard packaging solutions can be produced on thermoforming packaging machines and traysealers. And their paper and plastic parts can be separated quickly and reliably after use, so that they can be fed into separate recycling cycles.





# Recyclable plastics.

**20** Packaging that consists of only one material can be fed into the respective recycling loop after use, sorted by type. In addition to the established recycling processes for packaging made of glass, metal and paper, this also increasingly applies to packaging made of monoplastics such as APET.



With MULTIVAC APET+ films, you benefit from packaging solutions in which both the bottom film and the top film are made of mono-material and can be recycled by type. Since APET+ does not require an additional and non-grade-specific sealing layer, plastic consumption can be reduced by up to 15% compared to standard APET materials. APET+ can also be produced from up to 90% recycled PET (rPET), which again significantly reduces the carbon footprint.





# Automated, integrated and all from a single source.

22

## Gaining an edge with MULTIVAC lines

For fresh and frozen meat, fixed-weight packs optimize inventory control and significantly reduce waste after expiration of the minimum shelf life. In line with this trend, we offer our customers fully automated solutions for maximum productivity and hygiene. Such state-of-the-art lines reduce human contact and ensure maximum availability with fast product and format changes thanks to MULTIVAC Line Control (MLC).

Each of our lines is individually configured in terms of product infeed, packaging process, pack discharging, labelling, quality inspection and end-of-line packaging – and can, of course, be delivered turnkey on request. We will also support you with the implementation of Track & Trace systems, which make food traceable from the producer to the packaging.

Handling module  
for cartoning

Conveyor  
belt labeller

Checkweigher  
with metal detector

Traysealer



Our portfolio for packaging solutions in the areas of fresh, frozen or processed poultry products includes:

- Automated and fully integrated lines from a single source
- Thermoforming packaging machines
- Traysealers
- Flowpackers
- Labelling systems
- Inspection systems

**You too can benefit from the advantages of automated and integrated MULTIVAC solutions:**

- Synchronization of all components
- Simple control of all line elements via a uniform user interface
- Increased efficiency of the overall process
- Simplified product changeovers
- Reliable product transfer
- Increased process reliability
- Complete traceability at package level
- Storage of recipe data at the line level
- Uniform qualification

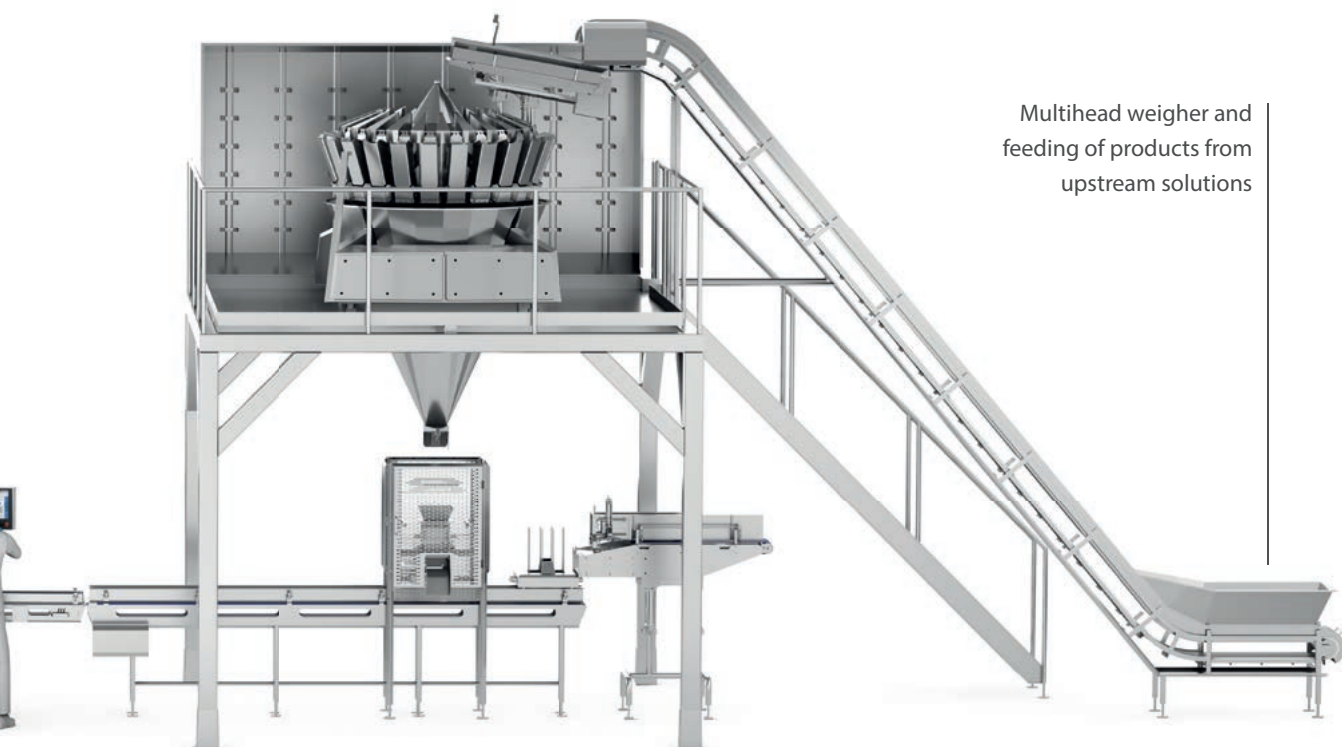

Multihead weigher and feeding of products from upstream solutions

← Running direction

# Line control and operation: Easier and more efficient thanks to MLC.

**24** MULTIVAC Line Control (MLC) makes the operation and handling of your packaging lines significantly easier and more efficient. This is because frequently recurring operating sequences become cross-line, standardized and reproducible processes. The operating personnel benefit from significantly shorter walking distances as well as simple, fast and error-free operating steps for:

- Starting up the line
- Starting and stopping the line
- Recipe changes across lines
- Emptying the line
- Line status overview

The net result is significantly higher availability of the entire line and a targeted minimization of operating errors. By processing all relevant process data, MULTIVAC Line Control also provides you with an ideal foundation for optionally usable digital services, such as OEE analyses, and is used for simple connection to ERP, MES, MRP or PPS systems.

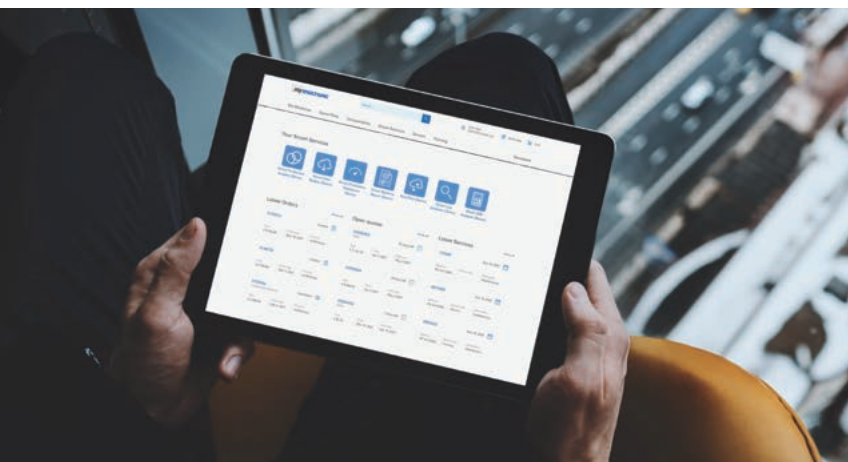



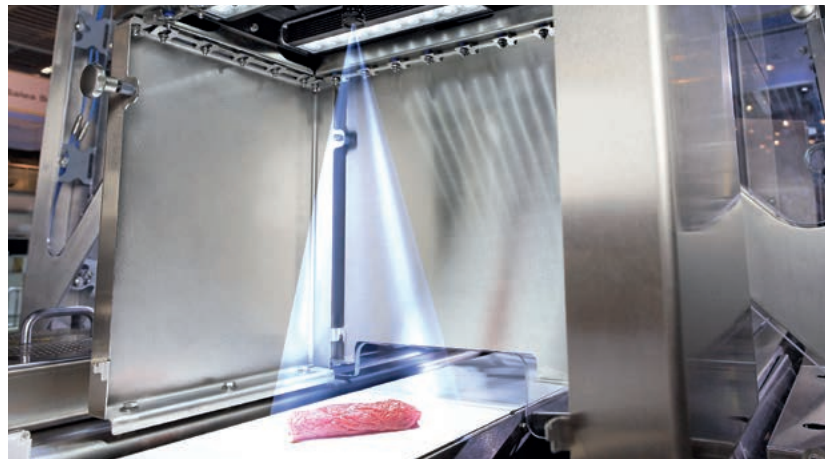
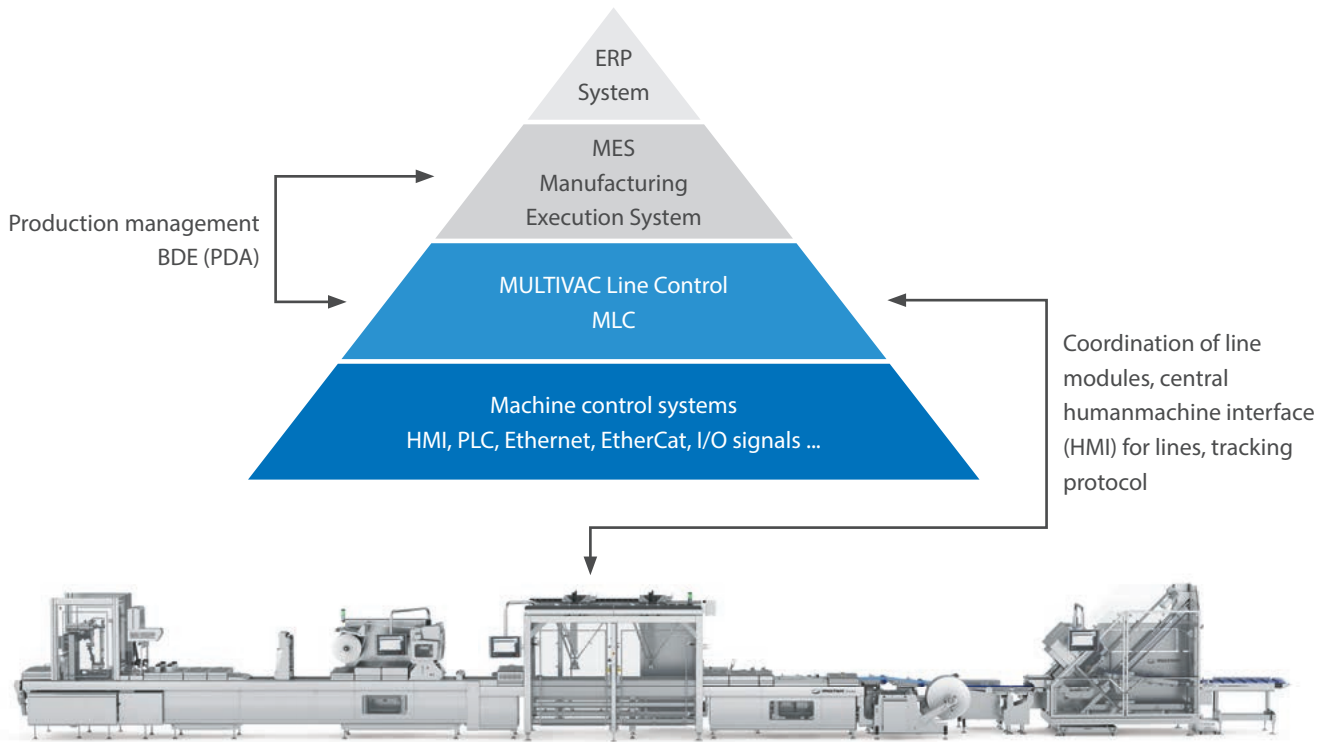

# Thermoformed packaging with an impressive variety of packs.

**26** Food products fill supermarket shelves in ever-increasing variety and in ever-new forms of presentation. Parallel to this, the choice of pack shapes and materials is also increasing. Their wide range of possibilities can be produced safely, reliably and efficiently on MULTIVAC thermoforming packaging machines.

MULTIVAC will design your machine according to your requirements in terms of pack design, performance and resource efficiency. As the world's leading manufacturer, we deliver over 1,000 thermoforming packaging machines for food products every year based on this principle.

With the X-line RX 4.0 thermoforming packaging machine, MULTIVAC is supporting digitalization in packaging processes and driving forward Industry 4.0 concepts.

Thanks to its comprehensive sensor technology and MULTIVAC Smart Services, X-line opens up new dimensions for our users when it comes to pack reliability, quality and performance, as well as transparent and efficient processes.

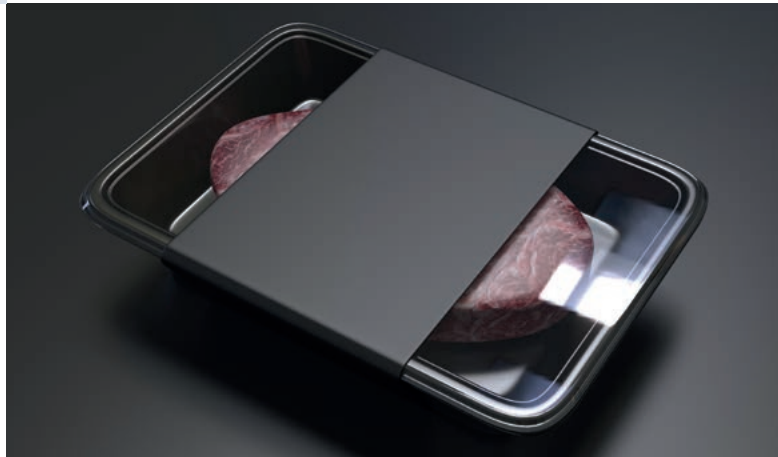



# Better packaging on MULTIVAC thermoforming packaging machines.

28

Reliable discharge  
and separation systems

Precise cutting systems  
for individual pack shapes

High seal seam quality  
for maximum pack reliability

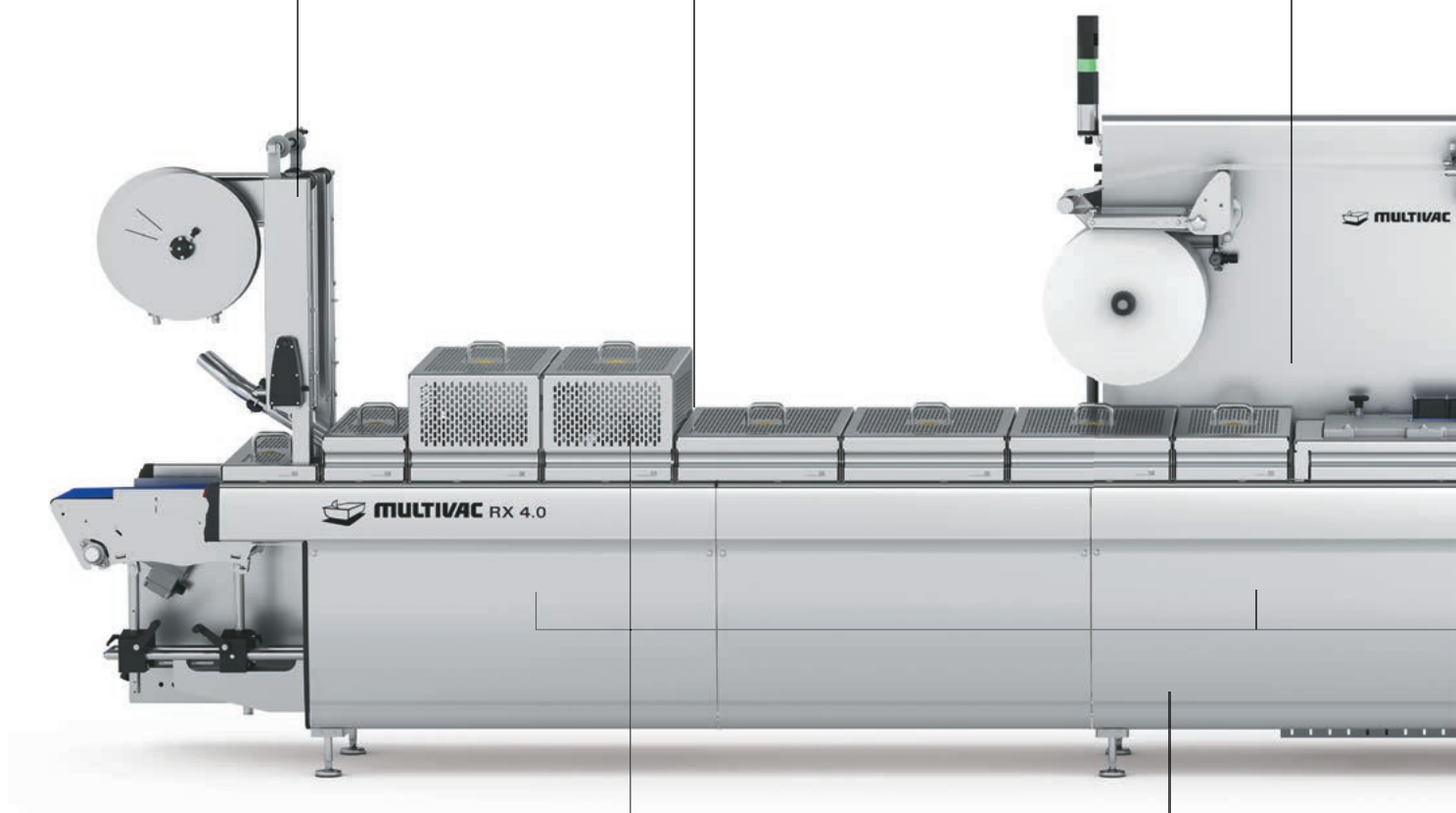

Maximum operator safety through  
comprehensive protective devices

Easily  
removable panels

---

**You too can benefit from the advantages of  
MULTIVAC thermoforming packaging solutions:**

- High production output and pack quality
- Individually tailored solutions in terms of pack shape, opening aids, reclosure, etc.
- MULTIVAC Hygienic Design™ for fast and reliable wet cleaning
- Process reliability and durability
- Reduced use of plastic films and energy
- Wide range of configurations and upgrades

Easy operation and maximum reliability thanks to Multi Sensor Control, Smart Services and Pack Pilot

Variably definable loading area for manual or automatic loading  
Reliable discharge and separation systems

Options for optimized film changeovers

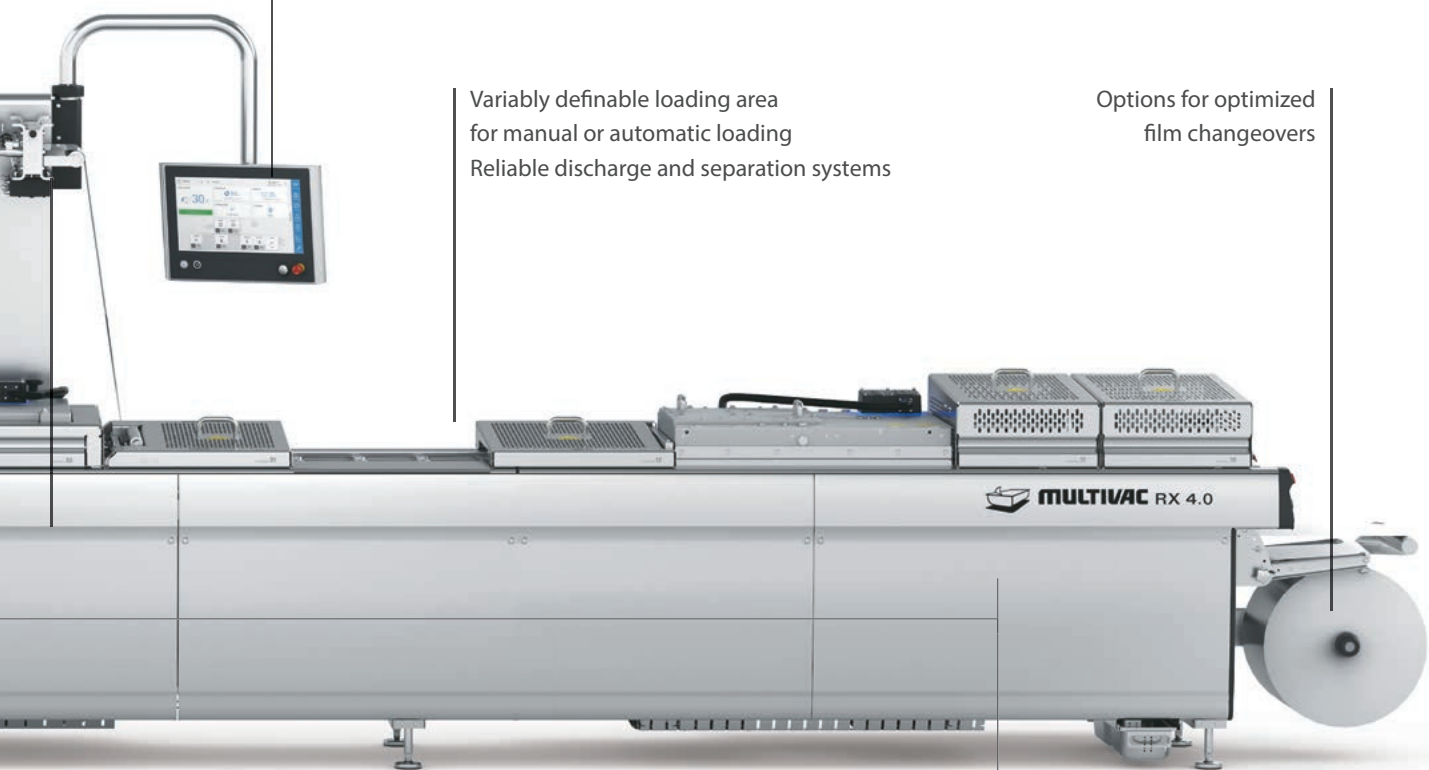

Fast format changes thanks to long-life, high-performance lifting units

# Traysealers for maximum flexibility and reliability.

**30** MULTIVAC X-line traysealers cover a wide range of food packaging applications per se, but are especially suitable for poultry products.

Their robust mechanical design and innovative control system with the Flow Manager and Multi Sensor Control features enable you to package products on the

MULTIVAC X-line with the greatest flexibility and consistent reliability – even at maximum output and in continuous operation. The frequent product, film and tool changes typical of traysealers can be carried out on the TX models with minimum interruption to production. This is because operators need less than ten minutes to change an X-tool.

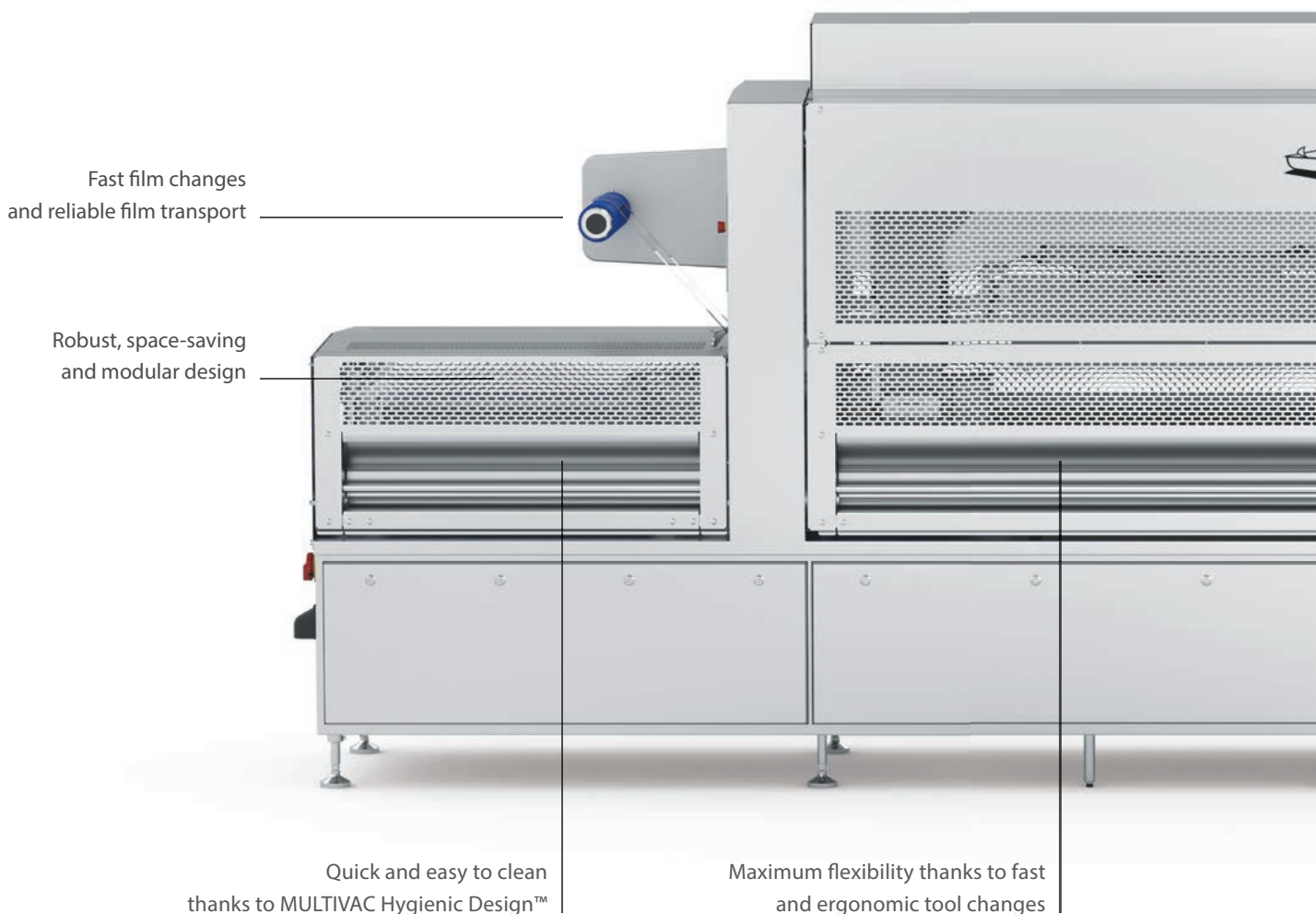

## MULTIVAC Hygienic Design™

You also save valuable time during cleaning. Thanks to MULTIVAC Hygienic Design™, even assemblies inside the machine, such as the film transport chain, the chain guide and the motors, are hygiene-optimized and easily accessible thanks to entirely removable side panels.

### You too can benefit from the advantages of the MULTIVAC X-line:

- MULTIVAC Hygienic Design™
- High production output and pack quality
- Individually tailored solutions
- Maximum performance on a minimum footprint
- Energy efficiency
- Pioneering ergonomics and user-friendliness
- Durability
- Comprehensive range of solutions for tray infeed and discharge
- Individual solutions for tray loading
- Complete offering for packaging lines

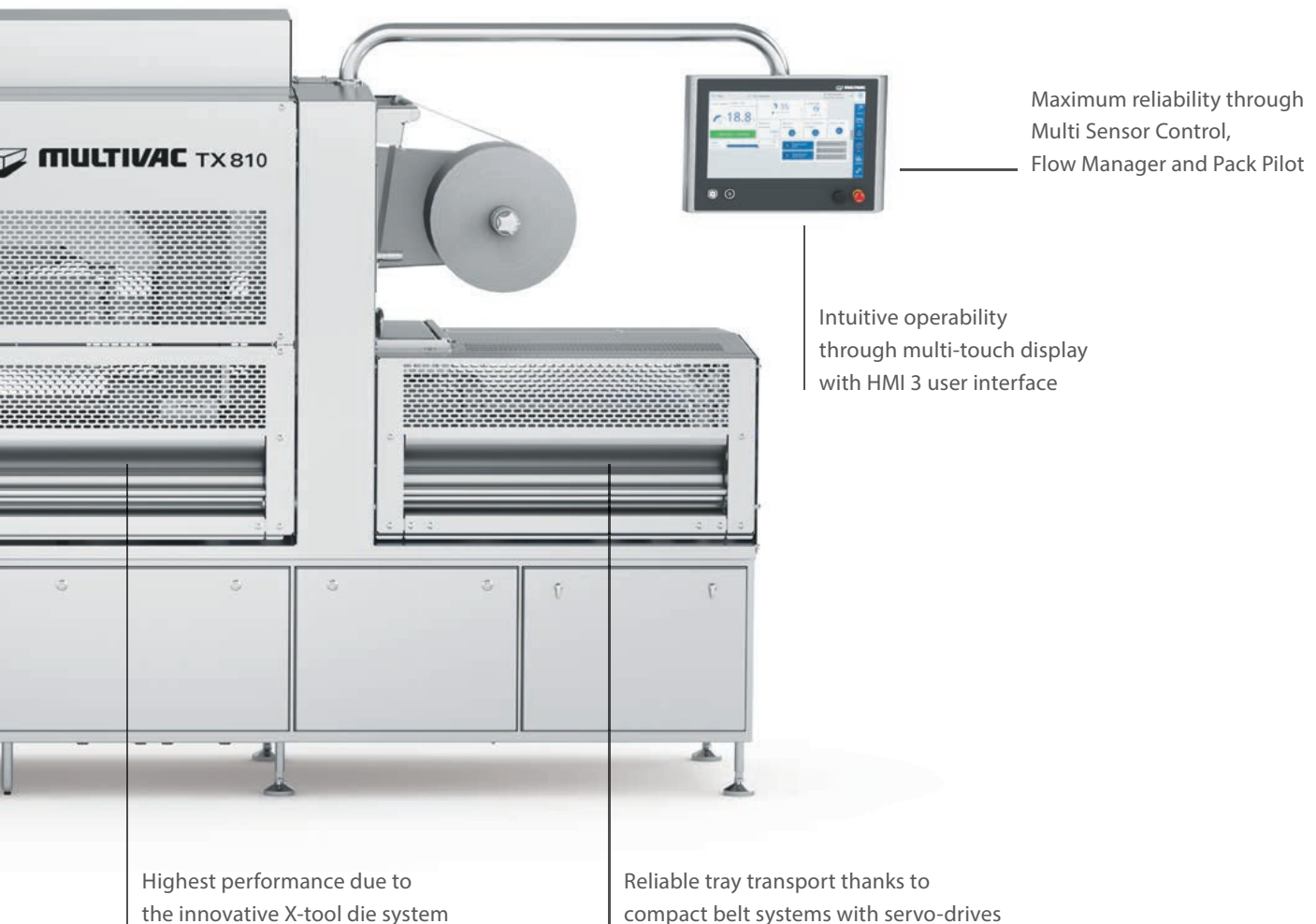

# More flexibility in packaging.

**32** MULTIVAC labellers place labels accurately on a wide variety of pack types. They are also extremely flexible in terms of label positioning, product handling, printing and inspection.

They can be seamlessly integrated into filling or packaging lines and can be used as a stand-alone solution with manual product infeed. Their modular design allows optimum technical and economic adaptation to all kinds of labelling tasks.

Operator terminal with  
HMI 2.0 user interface

High capacity  
label roll

Printer for variable  
printing of labels

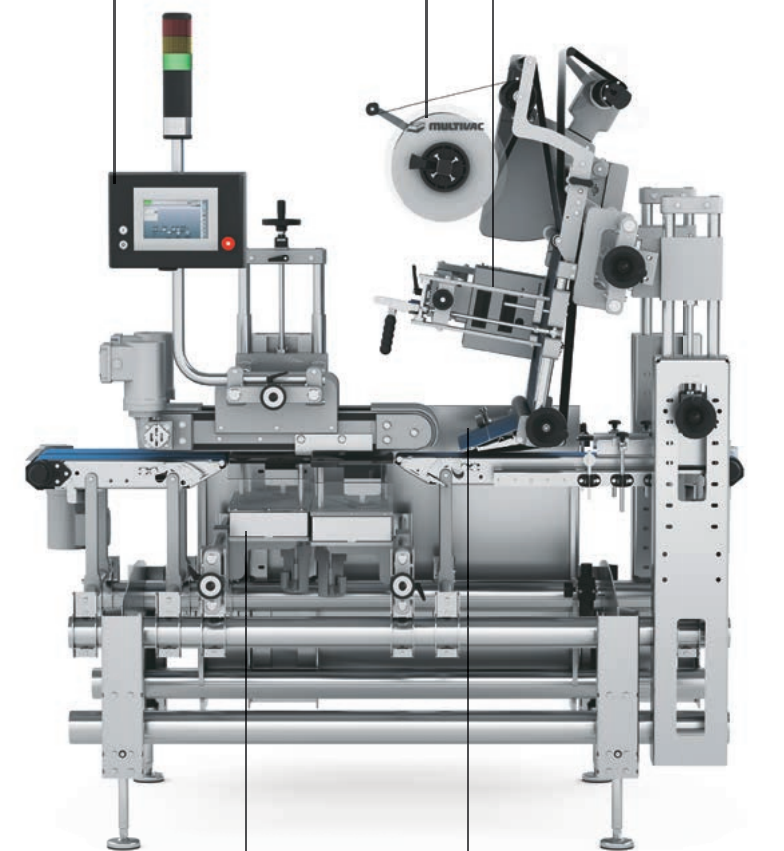

Label pressing device  
with servo-drive

Label dispenser for label tape  
up to 500 mm wide



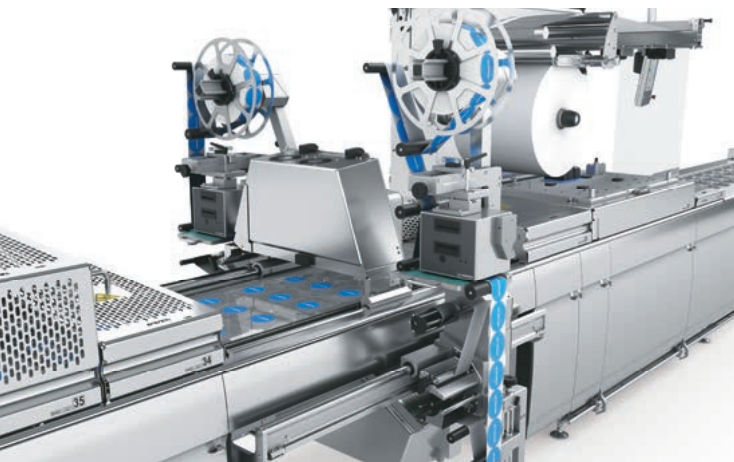

**You too can benefit from the advantages of MULTIVAC conveyor belt labellers:**

- Versatile for fully automatic C and D labeling as well as additional top and bottom labeling
- Highest labeling speed with up to 150 packs/min.
- Maximum precision due to exact guidance of the packs
- Simple operation via the intuitive MULTIVAC user interface
- Convenient adjustment devices for fast change-over to other pack formats and label sizes
- Wide range of options for individual configuration
- Can be flexibly expanded with additional label dispensers or modules for pack and label inspection



MAP trays

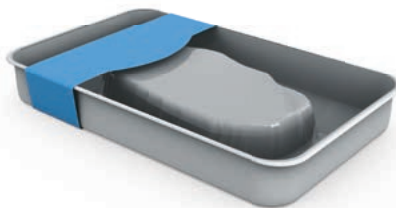

Skin trays

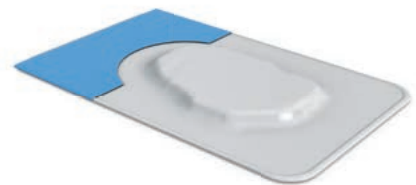

Sleeves



MAP thermoformed packaging



Skin thermoforming packaging



Flatboard

# Inspection systems for product and packaging control.

**34** Brand protection and consumer safety are becoming increasingly important. With innovative inspection systems from MULTIVAC, you benefit from efficient quality control and can ensure that the pack and its labelling are flawless.

From foreign object detection through weight control to end-of-package inspection, we offer you a broad a wide range of solutions that enable you to meet legal requirements while complying with the highest quality standards.

## Weight control

MULTIVAC checkweighers are available in different weighing ranges and designs:

- Checkweigher
- Checkweigher with metal detector
- Integrated ejector

## Metal detection

MULTIVAC has IFS-compatible, space-saving and high-performance detection solutions for contaminants with magnetic and non-magnetic metals in its range:

- Metal detectors
- Integrated ejectors



They can also be used to check the completeness of the package contents.

Packages containing metallic components such as clips, etc., can also be inspected with X-ray inspection systems.

X-ray inspection systems from MULTIVAC comply with the requirements of national and international standards food safety standards such as HACCP, IFS or BRC.

---

**You too can benefit from the advantages of MULTIVAC inspection systems:**

- Efficient automatic quality control of all packs
- Reliable rejection of incorrect or contaminated packs
- Combinability of different inspection methods in one device
- High reliability and durability
- Seamless integration into automated lines

## **X-ray inspection**

X-ray inspection systems detect metallic and non-metallic foreign bodies such as stones, glass or bones.



# State-of-the-art marking and packaging control.

36

Optical inspection systems for label and pack checking are integrated into MULTIVAC labelling systems or designed as a stand-alone inspection solution with a separate conveyor belt. Packs outside the tolerance range can therefore be rejected.

What's more, camera-based systems enable you to check, for example, whether a product is correctly positioned in the pack or whether a pack has been completely filled.



---

**You too can benefit from the advantages of  
MULTIVAC label and pack inspection:**

- Customer and consumer protection
- Protection of your own brand
- Avoidance of product recalls or penalties due to incorrect labeling
- Continuous quality improvement
- Seamless integration into automated lines



# MULTIVAC is there for you on-site, worldwide.

38

165

MULTIVAC supplies products and services in 165 countries.

6,900

Employees.  
Our most valuable capital.

200,000+

Packaging machines sold.

80+

More than 80 subsidiaries worldwide.

13

Production sites worldwide.

1.4

Billion euros turnover (MULTIVAC Group in 2021).

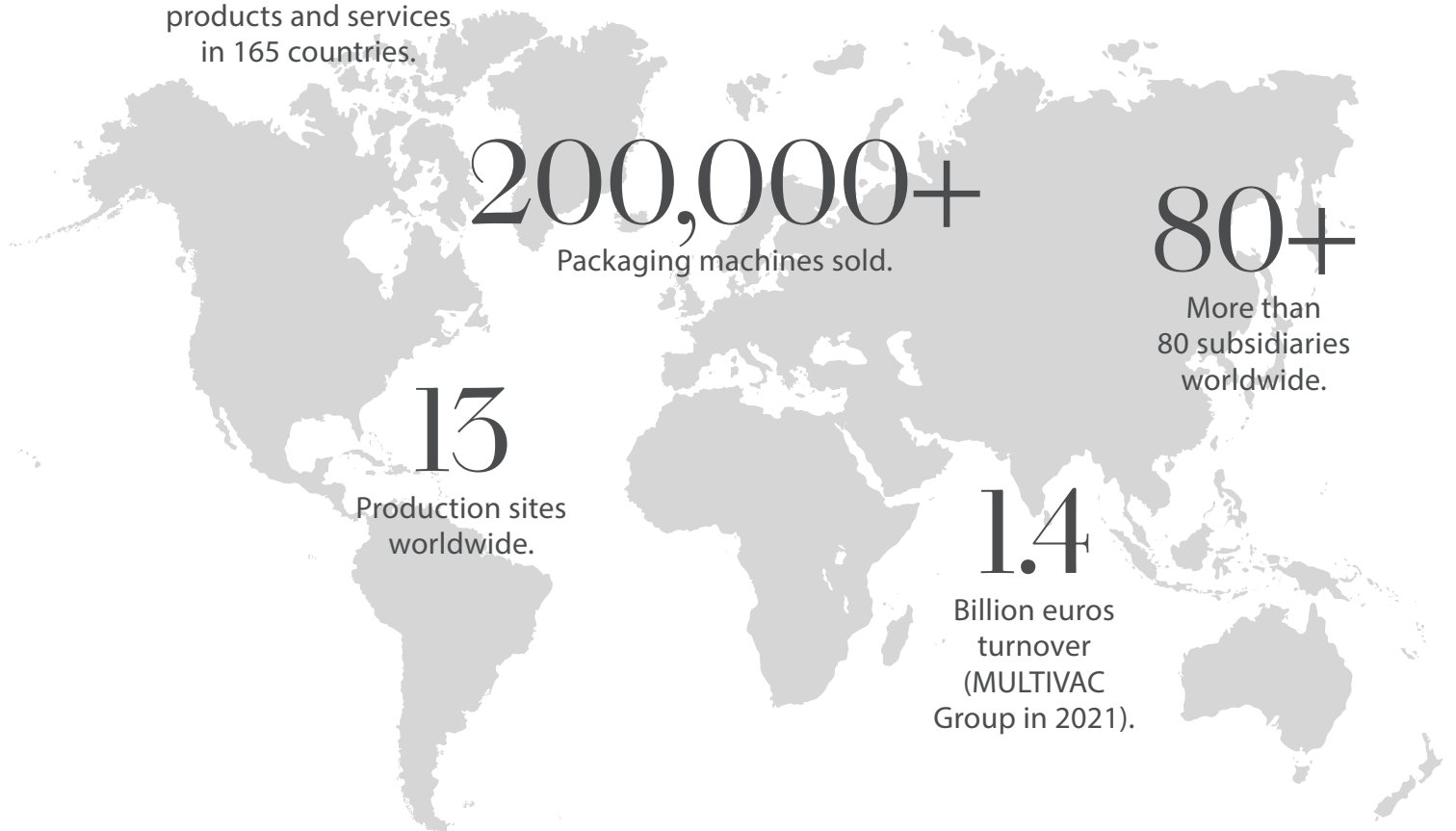

The MULTIVAC Group employs some 6,900 staff worldwide. With over 80 subsidiaries, the Group is represented on all continents. More than 1,000 advisors and service technicians support customers around the globe. Their know-how and experience provide the maximum availability for all installed MULTIVAC machines. At all times and in all places.





MULTIVAC is part of the R-Cycle initiative across all its companies. The common objective is to drive the loop system for plastic packs forward, based on an open and globally applicable tracing standard.



MULTIVAC supports the Blue Competence initiative of the Association of German Machinery and Equipment Manufacturers (VDMA).

109616314 © MULTIVAC 04/2022

Subject to technical changes in line with product development.

MULTIVAC is a registered trademark of MULTIVAC Sepp Haggenmüller SE & Co. KG.



[www.multivac.com](http://www.multivac.com)