

SOmmer **GA**rdinen **TEC**hnik

GROSSHANDEL FÜR
GARDINENTECHNIK

Produktübersicht

Sommer Gardinen Technik

Augsburgerstr. 7 87700 Memmingen

Fon. 08331.961872 – 0 Fax. 08331.961872 – 1

info@sogatec.de

www.sogatec.de







Abb.	Beschreibung	Farbe	Artikel	SB-Nr.	VE
	Rollring universal Rolle 7 mm <i>Achtung auch in langer Ausführung lieferbar 3,2cm</i>	weiss	Z/100	Z/100-SB	100 Stück 1000 Stück 5000 Stück 10000 Stück
	<i>weiß</i>		Z/100-lang		
				1 SB = 20St.	25 SB
	Rollring für MHZ	weiss	Z/101	Z/101-SB	100 Stück 1000 Stück 5000 Stück 10000 Stück
				1 SB = 20St.	25 SB
	U-Faltenrolle	weiss	Z/102	Z/102-SB	100 Stück 1000 Stück
				1 SB = 20St.	25 SB
	T-Rolle nickel/PVC weiss		Z/105	Z/105-SB	100 Stück
				1 SB = 20St.	25 SB
	T-Gleiter PVC	weiss	Z/106	Z/106-SB	100 Stück
				1 SB = 20St.	25 SB
	Gelenkgleiter Gardi-Klick 4 mm Laufnut 6 mm Laufnut	weiss	Z/107 Z/108	Z/107-SB Z/108-SB	500 Stück 500 Stück
				1 SB = 20St.	25 SB
	Gleiter Achslänge 10,8 mm Laufnut 5,9 – 6,8 mm Hakenlänge 25 mm	weiss	Z/109	Z/109-SB	100 Stück 500 Stück
				1 SB = 20St.	25 SB





Abb.	Beschreibung	Farbe	Artikel	SB – Nr.	VE
	Rollring für Alu Schienen	weiss	Z/111	Z/111-SB	100 St. 500 St. 1000 St. 1 SB = 20St. 25 SB
	Gelenk-Gleiter für Alu Schienen mit engem Lauf	weiss	Z/112	Z/112-SB	100 St. 500 St. 1000 St. 1 SB = 20St. 25 SB
	X-Falten-Gleiter Universal für Alu Schienen	weiss	Z/113	Z/113-SB	100 St. 500 St. 1000 St. 1 SB = 20St. 25 SB
	Gelenk-Gleiter für Alu Schienen	weiss	Z/114	Z/114-SB	100 St. 500 St. 1000 St. 1 SB = 20St. 25 SB
	Gleiter für Alufa	weiss	Z/121	Z/121-SB	100 St. 500 St. 1000 St. 1 SB = 20St. 25 SB
	Falten-Gleiter Kopf 7mm	weiss	Z/122	Z/122-SB	100 St. 1 SB = 20St. 25 SB





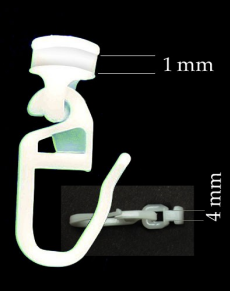

Abb.	Beschreibung	Farbe	Artikel	SB – Nr.	VE
	Falten – Gleiter Kopf 7mm	weiss	Z/122	Z/122 – SB 1 SB = 20St.	100 St. 500 St. 25 SB
	Steck – Gleiter Kopf 7mm	weiss	Z/123	Z/123 – SB 1 SB = 20St.	100 St. 500 St. 25 SB
	Kobra-Gleiter Kopf 7mm	weiss	Z/124	Z/124 – SB 1 SB = 20St.	100 St. 500 St. 25 SB
	Kobra-Gleiter Kopf 7mm	weiss	Z/125	Z/125 – SB 1 SB = 20St.	100 St. 500 St. 25 SB
	Gleiter „Rapid“ <i>zum Eindrehen</i> Laufbreite 4 mm	weiss	Z/126	Z/126 – SB 1 SB = 20St.	100 St. 25 SB
	Gleiter „Rapid“ <i>zum Eindrehen</i> Laufbreite 6 mm für Alu Schienen	weiss	Z/127	Z/127 – SB 1 SB = 20St.	100 St. 25 SB







Abb.	Beschreibung	Farbe	Artikel	SB-Nr.	VE
	Überklipshaken 4 mm	klar	Z/201-00	<i>Z/201-00-SB</i>	100St.
		weiss	Z/201-06	<i>Z/201-06-SB</i>	100St.
				<i>1 SB = 20St.</i>	25 SB
	Überklipshaken 5 mm	klar	Z/202-00	<i>Z/202-00-SB</i>	100St.
		weiss	Z/202-06	<i>Z/202-06-SB</i>	100St.
		gold	Z/202-24	<i>Z/202-24-SB</i>	100St.
		silber	Z/202-14	<i>Z/202-14-SB</i>	100St.
		schwarz	Z/202-15	<i>Z/202-15-SB</i>	100St.
		<i>1 SB = 20St.</i>	25 SB		
	Überklipshaken 7 mm	klar	Z/203-00	<i>Z/203-00-SB</i>	100St.
		weiss	Z/203-06	<i>Z/203-06-SB</i>	100St.
				<i>1 SB = 20St.</i>	25 SB
	Überklipshaken für Flachringe	klar	Z/204-00	<i>Z/204-00-SB</i>	100St.
		weiss	Z/204-06	<i>Z/201-06-SB</i>	100St.
		silber	Z/204-14	<i>Z/204-14-SB</i>	100St.
		schwarz	Z/204-15	<i>Z/204-15-SB</i>	100St.
		gold	Z/204-24	<i>Z/204-24-SB</i>	100St.
		<i>1 SB = 20St.</i>	25 SB		
	Überklipshaken 9 mm für 28 mm Ringe	klar	Z/205-00	<i>Z/205-00-SB</i>	100St.
		weiss	Z/205-06	<i>Z/205-06-SB</i>	100St.
		natur	Z/205-02	<i>Z/205-02-SB</i>	100St.
		braun	Z/205-03	<i>Z/205-03-SB</i>	100St.
		<i>1 SB = 20St.</i>	25 SB		









Abb.	Beschreibung	Farbe	Artikel	SB-Nr.	VE
	Endfeststeller Kobra 8mm		Z/301	Z/301-SB 1 SB = 6St.	100 St. 25 SB
	Endfeststeller Kombi 1.Stufe 10mm Kombi 2.Stufe 11mm		Z/302	Z/302-SB 1 SB = 6St.	100 St. 25 SB
	Endfeststeller Kombi 1.Stufe 12,5mm Kombi 2.Stufe 14,5mm		Z/303	Z/303-SB 1 SB = 6St.	100 St. 25 SB
	Endfeststeller 1.Stufe 16mm MHZ		Z/304	Z/304-SB 1 SB = 6St.	100 St. 25 SB
	Zwischenfeststeller <i>für U-Profil u. Ap-Schiene</i>		Z/305	Z/305-SB 1 SB = 6St.	100 St. 25 SB
	Zwischenfeststeller		Z/306	Z/306-SB 1 SB = 6St.	100 St. 25 SB
	Endfeststeller		Z/307	Z/307-SB 1 SB = 6St.	100 St. 25 SB
	Endfeststeller Universal		Z/308	Z/308-SB 1 SB = 6St.	100 St. 25 SB
	Feststeller für Laufbreite 4 mm und 6 mm		Z/309	Z/309-SB 1 SB = 6St.	100 St. 25 SB



Abb.	Beschreibung	Farbe	Artikel	SB-Nr.	VE
	Faltenleghaken für Raffrollo....	weiss	Z/206-06	Z/206-06-SB 1 SB = 20St.	100St. 25 SB
	Führungs - Doppelöse mit Schlitz und Annähplatte	transp.	Z/208-00	Z/208-00-SB 1 SB = 5 St.	100St. 25 SB
	Schnurregler	transp.	Z/209-00	Z/209-00-SB 1 SB = 5 St.	100St. 25 SB
	S - Haken mit Bandführung	weiss	Z/210-06	Z/210-06-SB 1 SB = 20St.	100St. 25 SB





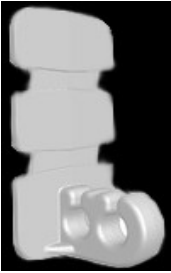

Abb.	Beschreibung	Farbe	Artikel	SB-Nr.	VE
	Klebeträger	weiss	Z/412-06	Z/412-06-SB	10 Paar 25 SB
		natur	Z/412-02	Z/412-02-SB	
		braun	Z/412-03	Z/412-03-SB	
				1 SB = 1 Paar	
	Vitragenhaken selbstklebend 18 x 24 mm	braun	Z/414-03	Z/414-03-SB	100 St. 25 SB
		weiss	Z/414-06	Z/414-06-SB	
				1 SB = 4St.	
	Vitragenhaken selbstklebend 18 x 24 mm	vermess.	Z/414-07	Z/414-07-SB	100 St. 25 SB
		chrom	Z/414-14	Z/414-14-SB	
				1 SB = 2St.	
	Klebehaken verstellbar	weiss	Z/415-06	Z/415-06-SB	100 St. 25 SB
		braun	Z/415-03	Z/415-03-SB	
				1 SB = 2St.	
	Raffhaken PVC selbstklebend 18 x 24 mm	weiss	Z/416-06	Z/416-06-SB	100 St. 25 SB
		braun	Z/416-03	Z/416-03-SB	
				1 SB = 4St.	
	Raffhaken PVC selbstklebend 18 x 24 mm	vermess.	Z/416-07	Z/416-07-SB	100 St. 25 SB
		chrom	Z/416-14	Z/416-14-SB	
				1 SB = 2St.	
	Klebehaken PVC 20 mm	weiss	Z/417-06	Z/417-06-SB	100 St.
		braun	Z/417-03	Z/417-02-SB	100 St.
		vermess.	Z/417-07	Z/417-03-SB	100 St.
		verchrom.	Z/417-14	Z/412-07-SB	100 St.
				1 SB = 2St.	25 SB

Abb.	Beschreibung	Farbe	Artikel	VE
	 <p>Klemmträger „Vario“ Grundträger - zur Montage direkt am Fensterrahmen ohne Kleben und Bohren! - Kombination mit verschiedenen Komponenten</p> <p>Geeignet für einen Klemmbereich (Profilbreite des Fensters) von 10 mm bis 25 mm.</p>	weiss	560	20 St.
	 <p>Scheiben-Gardinenhaken „Vario“ für Vitragenstangen</p>	weiss	532	100 St.
	 <p>Seitenlager „Vario“ für 12 mm</p>	weiss	41.12	100 St.
	 <p>Träger für Cafègarnituren „Vario“ für 12 mm</p>	weiss	27.12	100 St.
	 <p>Halter mit Befestigungsknebel „Vario“ für Alu und Kunststoffpaneele</p>	weiss	20PA WF	50 St.

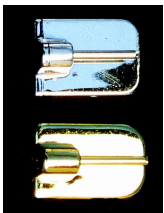

Klemmträger für Plissees

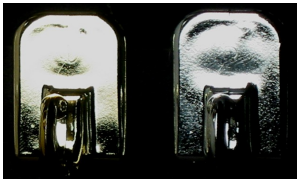
weiss

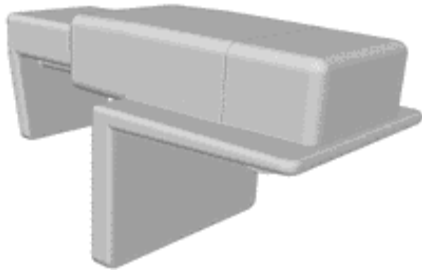
566

20 St.

verwendbar für Cosiflor®, Hunter Douglas
und Decomatik®

- mit Linsenschraube und Mutter zum Befestigen der Spannschuhe.

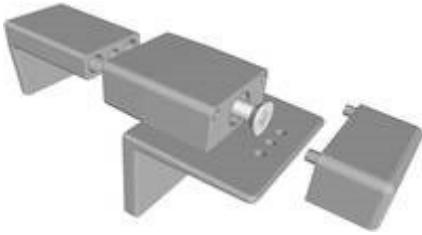

Geeignet für einen Klemmbereich
(Profilbreite des Fensters)
von 10 mm bis 25 mm.



! Achtung zur Montage bitte keinen Akkuschauber verwenden.







Abb.	Beschreibung	Farbe	Artikel	SB – Nr.	VE
	Donauklammern 10 mm	weiss	Z/430 – 06	Z/430-06-SB	100 St.
		vermess.	Z/430 – 07	Z/430-07-SB	100 St.
		vernickelt	Z/430 – 14	Z/430-14-SB	100 St.
				1 SB = 8St.	25 SB
	Donauklammern 16 mm	weiss	Z/432 – 06	Z/432-06-SB	100 St.
		vermess.	Z/432 – 07	Z/432-07-SB	100 St.
		vernickelt	Z/432 – 14	Z/432-14-SB	100 St.
				1 SB = 8St.	25 SB
	Donauklammern 22 mm	weiss	Z/434 – 06	Z/434-06-SB	100 St.
		vermess.	Z/434 – 07	Z/434-07-SB	100 St.
		vernickelt	Z/434 – 14	Z/434-14-SB	100 St.
				1 SB = 8St.	25 SB
	Donauklammern 35 mm	weiss	Z/436 – 06	Z/436-06-SB	100 St.
		vermess.	Z/436 – 07	Z/436-07-SB	100 St.
		vernickelt	Z/436 – 14	Z/436-14-SB	100 St.
				1 SB = 8St.	25 SB
	Donauklammern Motiv „Sonne“ 35 mm	weiss	Z/437 – 06	Z/437-06-SB	10 St.
		vermess.	Z/437 – 07	Z/437-07-SB	10 St.
		chrom	Z/437 – 14	Z/437-14-SB	10 St.
	Donauklammern Motiv „Mond“ 35 mm	schwarz	Z/437 – 15	Z/437-15-SB	10 St.
		mess.matt	Z/437 – 24	Z/437-24-SB	10 St.
		nickel.matt	Z/437 – 29	Z/437-29-SB	10 St.
				1 SB = 2St.	25 SB
	Donauklammern Motiv „Stern“ 35 mm				









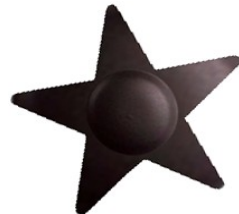



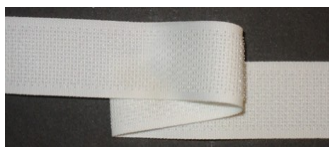
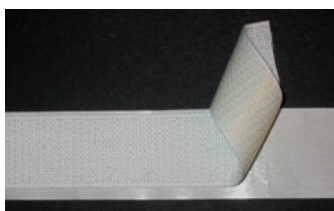

Abb.	Beschreibung	Farbe	Artikel	VE
	Schleuderstäbe <i>75 cm lang</i> 5 mm Stahl	weiss	Z/440 – 06	25 St.
	Schleuderstäbe <i>75 cm lang</i> Stahleinlage <i>plexi</i>	glasklar	Z/440 – 00	25 St.
	Schleuderstäbe <i>100 cm lang</i> 5 mm Stahl	weiss	Z/441 – 06	25 St.
	Schleuderstäbe <i>100 cm lang</i> Stahleinlage <i>plexi</i>	glasklar	Z/441 – 00	25 St.
	Schleuderstäbe <i>150 cm lang</i> 5 mm Stahl	weiss	Z/442 – 06	25 St.
	Schleuderstäbe <i>150 cm lang</i> Stahleinlage <i>plexi</i>	glasklar	Z/442 – 00	25 St.
	Auch Längen bis 250 cm möglich !			

Abb.	Beschreibung	Farbe	Artikel	VE
	Pilzkopfband 20 mm	weiss	Z/461	50 Mtr.
	Pilzkopfband selbstklebend 20 mm	weiss	Z/462-S	50 Mtr.
	Flauchband zum aufnähen 20 mm	weiss	Z/463	50 Mtr.
	Universalband 22 mm	weiss	Z/465	200 Mtr.
	Universalband 24 mm	transparent	Z/467	200 Mtr.
	Autom.- Faltenband 50 mm 2,0 :1 / 3 Falten 2,5 :1 / 3 Falten 3,0 :1 / 4 Falten	transparent	Z/469	100 Mtr.
	Smokfalte 50 mm 2,0 :1 2,5 :1 3,0 :1 variabel	transparent	Z/470	100 Mtr.

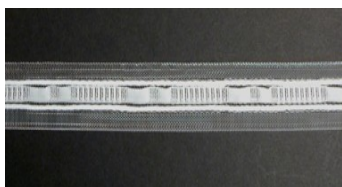
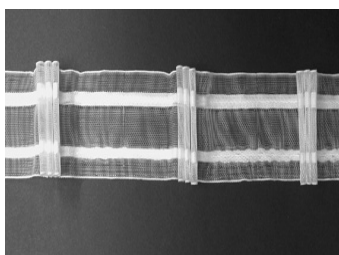
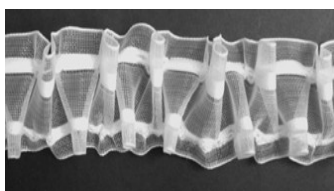
Weitere Bänder auf Anfrage !

Abb.	Beschreibung	Farbe	Artikel	SB-Nr.	VE
	Niroseil		S/500		5-10-15 Mtr.
	Seil-Feststeller	chrom	S/501-14		10 Stück
	Seil-Haken	vermessingt nickel	S/502-07 S/502-14	S/502-07-SB S/502-14-SB	100 Stück 1SB = 20St. 25 SB
	Ringklammer	vermessingt nickel	S/504-07 S/504-14	S/504-07-SB S/504-14-SB	100 Stück 100 Stück 1SB = 20St. 25 SB
	Ringklammer	vermessingt nickel	S/505-07 S/505-14	S/505-07-SB S/505-14-SB	100 Stück 100 Stück 1SB = 20St. 25 SB

Seilgarnituren auf Anfrage

Schwenkstange

ausziehbar

12 mm Durchmesser



ausziehbar: 30 - 50cm

60 - 110cm

VE 10 Stück

VE 10 Stück

Artikelnr.

Artikelnr.

V/799 - Silber

V/799 - Schwarz

Abb.	Beschreibung	Farbe	Artikel	VE
	Messing – massiv	weiss	V/640-06	10
	Vitragenstange	brüniert	V/640-31	10
	"Classic" 40cm	mess.pol.	V/640-08	10
	inkl. Haken	chrom	V/640-14	10
	100 % Innenlänge	nickel-matt	V/640-29	10
		mess.matt	V/640-24	10

	Messing – massiv	weiss	V/660-06	10
	Vitragenstange	brüniert	V/660-31	10
	"Classic" 60cm	mess.pol.	V/660-08	10
	inkl. Haken	chrom	V/660-14	10
	100 % Innenlänge	nickel-matt	V/660-29	10
		mess.matt	V/660-24	10

	Messing – massiv	weiss	V/680-06	10
	Vitragenstange	brüniert	V/680-31	10
	"Classic" 80cm	mess.pol.	V/680-08	10
	inkl. Haken	chrom	V/680-14	10
	100 % Innenlänge	nickel-matt	V/680-29	10
		mess.matt	V/680-24	10

	Messing – massiv	weiss	V/700-06	10
	Vitragenstange	brüniert	V/700-31	10
	"Classic" 100cm	mess.pol.	V/700-08	10
	inkl. Haken	chrom	V/700-14	10
	100 % Innenlänge	nickel-matt	V/700-29	10
		mess.matt	V/700-24	10







Abb.	Beschreibung	Farbe	Artikel	Länge	
	Vitragenstange	weiss/mess	VI704-06/7	30 – 45cm/ 8mm	VE 10 St.
	<i>Domina</i>		VI705-06/7	45 – 60cm/ 8mm	VE 10 St.
	8 mm		VI706-06/7	60 – 80cm/ 8mm	VE 10 St.
	<i>Enden messing massiv</i>		VI708-06/7	80 -140cm/10mm	VE 10 St.
	Vitragenstange	Silber	VI704-29	30 – 40cm/10mm	VE 10 St.
	<i>Domina</i>		VI705-29	40 – 60cm/10mm	VE 10 St.
	8 mm		VI706-29	60 – 80cm/10mm	VE 10 St.
	<i>Enden messing massiv nickel.matt lackiert</i>		VI708-29	80 -140cm/10mm	VE 10 St.
	Vitragenstange	weiss/chrom	VI704-06/14	30 – 45cm/ 8mm	VE 10 St.
	<i>Domina</i>		VI705-06/14	45 – 60cm/ 8mm	VE 10 St.
	8 mm		VI706-06/14	60 – 80cm/ 8mm	VE 10 St.
	<i>Enden messing massiv vernickelt</i>		VI708-06/14	80 -140cm/10mm	VE 10 St.
	Vitragenstange	mess./mess.	VI704-07/07	30 – 45cm/ 8mm	VE 10 St.
	<i>Domina</i>		VI705-07/07	45 – 60cm/ 8mm	VE 10 St.
	8 mm		VI706-07/07	60 – 80cm/ 8mm	VE 10 St.
	<i>Enden messing massiv</i>		VI708-07/07	80 -140cm/10mm	VE 10 St.

Abb.	Beschreibung	Farbe	Artikel	SB-Nr.	Stück SB	Stück/Lose
	Vitragenstange	weiss				
	100% Innenlänge					
	Oval flach	inkl. Haken				
					1 SB = 2St.	
	30cm		V/753-06	V/753-06-SB	VE 25 SB	VE 50 Stück
	40cm		V/754-06	V/754-06-SB	VE 25 SB	VE 50 Stück
	50cm		V/755-06	V/755-06-SB	VE 25 SB	VE 50 Stück
	60cm		V/756-06	V/756-06-SB	VE 25 SB	VE 50 Stück
80cm		V/758-06	V/758-06-SB	VE 25 SB	VE 50 Stück	
100cm		V/760-06	V/760-06-SB	VE 25 SB	VE 50 Stück	

	Vitragenstange	messing.matt				
	100% Innenlänge					
	Oval flach	inkl. Haken				
					1 SB = 2St.	
	30cm		V/753-24	V/753-24-SB	VE 25 SB	VE 50 Stück
	40cm		V/754-24	V/754-24-SB	VE 25 SB	VE 50 Stück
	50cm		V/755-24	V/755-24-SB	VE 25 SB	VE 50 Stück
	60cm		V/756-24	V/756-24-SB	VE 25 SB	VE 50 Stück
80cm		V/758-24	V/758-24-SB	VE 25 SB	VE 50 Stück	
100cm		V/760-24	V/760-24-SB	VE 25 SB	VE 50 Stück	



	Vitragenstange	silber.matt				
	100% Innenlänge					
	Oval flach	inkl. Haken				
					1 SB = 2St.	
	30cm		V/753-29	V/753-29-SB	VE 25 SB	VE 50 Stück
	40cm		V/754-29	V/754-29-SB	VE 25 SB	VE 50 Stück
	50cm		V/755-29	V/755-29-SB	VE 25 SB	VE 50 Stück
	60cm		V/756-29	V/756-29-SB	VE 25 SB	VE 50 Stück
80cm		V/758-29	V/758-29-SB	VE 25 SB	VE 50 Stück	
100cm		V/760-29	V/760-29-SB	VE 25 SB	VE 50 Stück	

Abb.	Beschreibung	Farbe	Artikel	SB-Nr.	Stück SB	Stück/Lose
	Klemmstange	weiss				
	"Pinn" inkl. Fixpunkte					
	30 - 35cm		V782-06	V/782-06-SB	VE 20 St.	20 St.
	35 - 45cm		V783-06	V/783-06-SB	VE 20 St.	20 St.
	45 - 55cm		V784-06	V/784-06-SB	VE 20 St.	20 St.
	50 - 60cm		V785-06	V/785-06-SB	VE 20 St.	20 St.
	60 - 70cm		V786-06	V/786-06-SB	VE 20 St.	20 St.
	70 - 80cm		V787-06	V/787-06-SB	VE 20 St.	20 St.
	80 - 90cm		V788-06	V/788-06-SB	VE 20 St.	20 St.
90 - 100cm		V789-06	V/789-06-SB	VE 20 St.	20 St.	
100 - 115cm		V790-06	V/790-06-SB	VE 20 St.	20 St.	



Klemmstange	messing.matt					
"Pinn" inkl. Fixpunkte						
30 - 40cm		V783-24	V/783-24-SB	VE 20 St.	20 St.	
40 - 50cm		V784-24	V/784-24-SB	VE 20 St.	20 St.	
50 - 65cm		V785-24	V/785-24-SB	VE 20 St.	20 St.	
65 - 80cm		V786-24	V/786-24-SB	VE 20 St.	20 St.	
80 - 95cm		V788-24	V/788-24-SB	VE 20 St.	20 St.	
95 - 110cm		V789-24	V/789-24-SB	VE 20 St.	20 St.	
110 - 125cm		V790-24	V/790-24-SB	VE 20 St.	20 St.	



Klemmstange	silber					
"Pinn" inkl. Fixpunkte						
30 - 40cm		V783-29	V/783-29-SB	VE 20 St.	20 St.	
40 - 50cm		V784-29	V/784-29-SB	VE 20 St.	20 St.	
50 - 65cm		V785-29	V/785-29-SB	VE 20 St.	20 St.	
65 - 80cm		V786-29	V/786-29-SB	VE 20 St.	20 St.	
80 - 95cm		V788-29	V/788-29-SB	VE 20 St.	20 St.	
95 - 110cm		V789-29	V/789-29-SB	VE 20 St.	20 St.	
110 - 125cm		V790-29	V/790-29-SB	VE 20 St.	20 St.	

Abb.	Beschreibung	Farbe	Artikel	SB-Nr.	Stück/SB	Stück/Lose
	„Pinn soft“	weiss				
	8 / 40 - 50cm		V/794-06	V/794-06-SB	VE 20 St.	VE 20 St.
	10 / 50 - 65cm		V/795-06	V/795-06-SB	VE 20 St.	VE 20 St.
	10 / 65 - 80cm		V/796-06	V/786-06-SB	VE 20 St.	VE 20 St.
	10 / 80 - 95cm		V/797-06	V/798-06-SB	VE 20 St.	VE 20 St.
	10 / 95 - 110cm		V/799-06	V/799-06-SB	VE 20 St.	VE 20 St.
	10 / 110 - 125cm		V/800-06	V/800-06-SB	VE 20 St.	VE 20 St.



„Pinn soft“	silber					
8 / 40 - 50cm		V/794-29	V/794-29-SB	VE 20 St.	VE 20 St.	
10 / 50 - 65cm		V/795-29	V/795-29-SB	VE 20 St.	VE 20 St.	
10 / 65 - 80cm		V/796-29	V/796-29-SB	VE 20 St.	VE 20 St.	
10 / 80 - 95cm		V/798-29	V/798-29-SB	VE 20 St.	VE 20 St.	
10 / 95 - 110cm		V/799-29	V/799-29-SB	VE 20 St.	VE 20 St.	
10 / 110 - 125cm		V/800-29	V/800-29-SB	VE 20 St.	VE 20 St.	

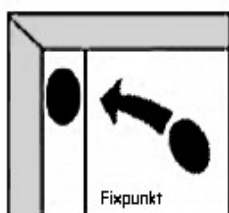

Fixpunkte

Z/000-06	Z/000-00-SB	VE 20 St.	VE 20 St.
----------	-------------	-----------	-----------



Perfekt-Line mit Spannsystem

für Fensterflügelstärken 10 – 18 mm

30 – 50cm	V/833	V/833-SB	VE 10 St.	VE 10 St.
50 – 80cm	V/835	V/835-SB	VE 10 St.	VE 10 St.
80 – 140cm	V/838	V/838-SB	VE 10 St.	VE 10 St.

Bitte Farbe angeben: 06 = weiss / 24 = mess.matt / 29 = nickel.matt

Abb.	Beschreibung	Farbe	Artikel	VE
	Klemmstange <i>"Presto"</i>	verbesserte Ausführung !		
	30 - 40 cm 40 - 60 cm 60 - 80 cm 80 - 100 cm 95 - 130 cm	weiss/mess	V/713- 06/08 V/714- 06/08 V/716- 06/08 V/718- 06/08 V/719- 06/08	5 St.
	30 - 40 cm 40 - 60 cm 60 - 80 cm 80 - 100 cm 95 - 130 cm	weiss/chrom	V/713- 06/14 V/714- 06/14 V/716- 06/14 V/718- 06/14 V/719- 06/14	5 St.
	30 - 40 cm 40 - 60 cm 60 - 80 cm 80 - 100 cm 95 - 130 cm	weiss/weiss	V/713- 06/06 V/714- 06/06 V/716- 06/06 V/718- 06/06 V/719- 06/06	5 St.
	30 - 40 cm 40 - 60 cm 60 - 80 cm 80 - 100 cm 95 - 130 cm	mess/mess	V/713- 08/08 V/714- 08/08 V/716- 08/08 V/718- 08/08 V/719- 08/08	5 St.
	30 - 40 cm 40 - 60 cm 60 - 80 cm 80 - 100 cm 95 - 130 cm	silber/silber	V/713- 29/29 V/714- 29/29 V/716- 29/29 V/718- 29/29 V/719- 29/29	5 St.



Abb.	Beschreibung	Farbe	Artikel	SB-Nr.	VE
	Raffhaken	messing	H/801- 08	H/801-08-SB 1 SB = 2St.	50 St. 25 SB
	Raffhaken 30 mm	messing chrom weiss ni.matt schwarz	H/802- 08 H/802- 14 H/802- 06 H/802- 29 H/802- 15	H/802-08-SB H/802-14-SB H/802-06-SB H/802-29-SB H/802-15-SB 1 SB = 2St.	50 St. 25 SB
	Raffhaken <i>Lilienform</i> <i>Länge 50mm</i> <i>Wandabstand 21mm</i>	messing chrom weiss ni.matt bronziert	H/803- 08 H/803- 14 H/803- 06 H/803- 29 H/803- 31	H/803-08-SB H/803-14-SB H/803-06-SB H/803-29-SB H/803-31-SB 1 SB = 2St.	50 St. 25 SB
	Raffhaken <i>Wandabstand 30mm</i> <i>Rosette 20mm</i>	weiss messing chrom schwarz nickel/matt bronziert	H/804- 06 H/804- 08 H/804- 14 H/804- 15 H/804- 29 H/804- 31	H/804-06-SB H/804-08-SB H/804-14-SB H/804-15-SB H/804-29-SB H/804-31-SB 1 SB = 2St.	50 St. 25 SB
	Raffhaken <i>Wandabstand 37mm</i> <i>Rosette 24mm</i>	weiss messing chrom schwarz nickel/matt bronziert	H/805- 06 H/805- 08 H/805- 14 H/805- 15 H/805- 29 H/805- 31	H/805-06-SB H/805-08-SB H/805-14-SB H/805-15-SB H/805-29-SB H/805-31-SB 1 SB = 2St.	50 St. 25 SB





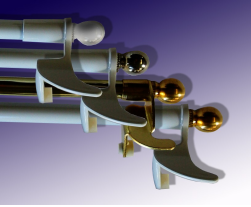
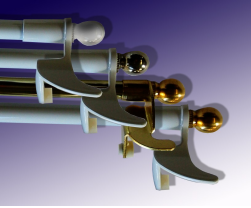
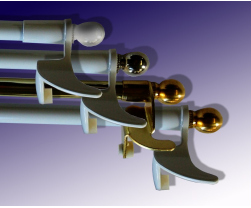
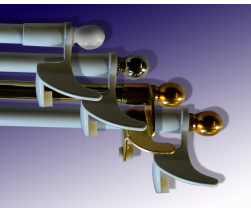
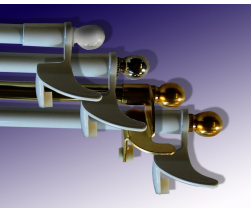

Abb.	Beschreibung	Farbe	Artikel	SB-Nr.	VE
	Haken	messing vernickelt	H/806- 08 H/806- 14	H/806-08-SB H/806-14-SB 1 SB = 2St.	50 St. 25 SB
	Raffhaken mit Rosette ca. 26mm	messing nickel glanz ni.matt	H/807- 08 H/807- 14 H/807- 29	H/807- 08-SB H/807- 14-SB H/807- 29-SB 1 SB = 2St.	50 St. 25 SB
	Raffhaken mit Rosette ca. 39mm	messing nickel glanz ni.matt	H/808- 08 H/808- 14 H/808- 29	H/808- 08-SB H/808- 14-SB H/808- 29-SB 1 SB = 2St.	50 St. 25 SB
	Raffhaken Sonne ca. 28mm	messing Oberfläche	H/809- 07	H/809- 07-SB 1 SB = 2St.	100 St. 25 SB
	Raffhaken Stern ca. 28mm	messing Oberfläche	H/810- 07	H/810- 07-SB 1 SB = 2St.	100 St. 25 SB
	Stahlnägel 1,4 x 26 mm	vermessingt	H/811- 07	H/811- 07-SB 1 SB = 20St.	100 St. 25 SB

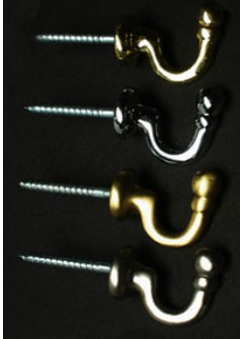
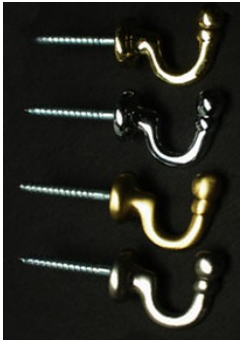

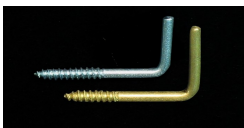

Abb.	Beschreibung	Farbe	Artikel	SB-Nr.	VE
	Raffhaken				
	8 cm	weiss	A/808-06	A/808-06-SB	10 St.
		messing	A/808-08	A/808-08-SB	10 St.
		chrom	A/808-14	A/808-14-SB	10 St.
		mess/matt	A/808-24	A/802-24-SB	10 St.
		nickel/matt	A/808-29	A/808-29-SB	10 St.
		bronziert	A/808-32	A/808-32-SB 1SB = 1St.	10 St. 10 SB
	Raffhaken				
	10 cm	weiss	A/810-06	A/810-06-SB	10 St.
		messing	A/810-08	A/810-08-SB	10 St.
		chrom	A/810-14	A/810-14-SB	10 St.
		mess/matt	A/810-24	A/810-24-SB	10 St.
		nickel/matt	A/810-29	A/810-29-SB	10 St.
		bronziert	A/810-32	A/810-32-SB 1SB = 1St.	10 St. 10 SB
	Raffhaken				
	18 cm	weiss	A/818-06	A/818-06-SB	10 St.
		messing	A/818-08	A/818-08-SB	10 St.
		chrom	A/818-14	A/818-14-SB	10 St.
		mess/matt	A/818-24	A/818-24-SB	10 St.
		nickel/matt	A/818-29	A/818-29-SB	10 St.
		bronziert	A/818-32	A/818-32-SB 1SB = 1St.	10 St. 10 SB
	Raffhaken				
	20 cm	weiss	A/820-06	A/820-06-SB	10 St.
		messing	A/820-08	A/820-08-SB	10 St.
		chrom	A/820-14	A/820-14-SB	10 St.
		mess/matt	A/820-24	A/820-24-SB	10 St.
		nickel/matt	A/820-29	A/820-29-SB	10 St.
		bronziert	A/820-32	A/820-32-SB 1SB = 1St.	10 St. 10 SB
	Raffhaken				
	25 cm	weiss	A/825-06	A/825-06-SB	10 St.
		messing	A/825-08	A/825-08-SB	10 St.
		chrom	A/825-14	A/825-14-SB	10 St.
		mess/matt	A/825-24	A/825-24-SB	10 St.
		nickel/matt	A/825-29	A/825-29-SB	10 St.
		bronziert	A/825-32	A/825-32-SB 1SB = 1St.	10 St. 10 SB

Abb.	Beschreibung	Farbe	Artikel	SB-Nr.	VE
Abstandshalter					
6 cm					
	weiss		A/852-06	A/852-06-SB	10 St.
	messing		A/852-08	A/852-08-SB	10 St.
	chrom		A/852-14	A/852-14-SB	10 St.
	schwarz		A/852-15	A/852-15-SB	10 St.
	mess/matt		A/852-24	A/852-24-SB	10 St.
	nickel/matt		A/852-29	A/852-29-SB	10 St.
	bronziert		A/852-32	A/852-32-SB	10 St.
				1SB = 1St.	10 SB

Abstandshalter					
10 cm					
	weiss		A/853-06	A/853-06-SB	10 St.
	messing		A/853-08	A/853-08-SB	10 St.
	chrom		A/853-14	A/853-14-SB	10 St.
	schwarz		A/853-15	A/853-15-SB	10 St.
	mess/matt		A/853-24	A/853-24-SB	10 St.
	nickel/matt		A/853-29	A/853-29-SB	10 St.
	bronziert		A/853-32	A/853-32-SB	10 St.
				1SB = 1St.	10 SB

Abstandshalter					
15 cm					
	weiss		A/854-06	A/854-06-SB	10 St.
	messing		A/854-08	A/854-08-SB	10 St.
	chrom		A/854-14	A/854-14-SB	10 St.
	schwarz		A/854-15	A/854-15-SB	10 St.
	mess/matt		A/854-24	A/854-24-SB	10 St.
	nickel/matt		A/854-29	A/854-29-SB	10 St.
	bronziert		A/854-32	A/854-32-SB	10 St.
				1SB = 1St.	10 SB



Abstandshalter					
20 cm					
	weiss		A/855-06	A/855-06-SB	10 St.
	messing		A/855-08	A/855-08-SB	10 St.
	chrom		A/855-14	A/855-14-SB	10 St.
	schwarz		A/855-15	A/855-15-SB	10 St.
	mess/matt		A/855-24	A/855-24-SB	10 St.
	nickel/matt		A/855-29	A/855-29-SB	10 St.
	bronziert		A/855-32	A/855-32-SB	10 St.
				1SB = 1St.	10 SB

Abb.	Beschreibung	Farbe	Artikel	SB-Nr.	VE
Abstandshalter					
25 cm					
	weiss		A/856-06	A/856-06-SB	10 St.
	messing		A/856-08	A/856-08-SB	10 St.
	chrom		A/856-14	A/856-14-SB	10 St.
	schwarz		A/856-15	A/856-15-SB	10 St.
	mess/matt		A/856-24	A/856-24-SB	10 St.
	nickel/matt		A/856-29	A/856-29-SB	10 St.
	bronziert		A/856-32	A/856-32-SB	10 St.
			1SB = 1St.	10 SB	

Abstandshalter					
30 cm					
	weiss		A/857-06	A/857-06-SB	10 St.
	messing		A/857-08	A/857-08-SB	10 St.
	chrom		A/857-14	A/857-14-SB	10 St.
	schwarz		A/857-15	A/857-15-SB	10 St.
	mess/matt		A/857-24	A/857-24-SB	10 St.
	nickel/matt		A/857-29	A/857-29-SB	10 St.
	bronziert		A/857-32	A/857-32-SB	10 St.
			1SB = 1St.	10 SB	

Raffarm 16 cm					
Wandabstand 7,5 cm					
	messing		A/860-08	A/860-08-SB	2 St.
	chrom		A/860-14	A/860-14-SB	2 St.
	mess/matt		A/860-24	A/860-24-SB	2 St.
	nickel/matt		A/860-29	A/860-29-SB	2 St.
				1SB = 1St.	10 SB

Raffarm 27 cm					
Wandabstand 8 cm					
	messing		A/861-08	A/861-08-SB	2 St.
	chrom		A/861-14	A/861-14-SB	2 St.
	mess/matt		A/861-24	A/861-24-SB	2 St.
	nickel/matt		A/861-29	A/861-29-SB	2 St.
				1SB = 1St.	10 SB







Abb.	Beschreibung	Farbe	Artikel	SB-Nr.	VE
	Messing-Hohlring 11/16 mm	messing	R/900- 08	R/900- SB – 08 1 SB = 15St.	100 St. 25 SB
	Messing-Hohlring 13/18 mm	messing	R/901- 08	R/901- SB – 08 1 SB = 15St.	100 St. 25 SB
	Messing-Hohlring 15/20 mm	messing	R/902- 08	R/902- SB – 08 1 SB = 10St.	100 St. 25 SB
	Gardinenring PVC 11/16 mm	klar weiss	R/905- 00 R/905- 06	R/905- SB - 00 R/905- SB - 06 1 SB = 20St.	100 St. 100 St. 25 SB
	Gardinenring PVC 13/18 mm	klar weiss	R/906- 00 R/906- 06	R/906- SB - 00 R/906- SB - 06 1 SB = 15St.	100 St. 100 St. 25 SB
	Gardinenring PVC 16/21 mm	weiss	R/907- 06	R/907- SB - 06 1 SB = 10St.	100 St. 25 SB





Abb.	Beschreibung	Farbe	Artikel	SB-NR	VE
	Duschringe 35 mm	weiss	R/910-06	R/910-06-SB 1 SB = 8St.	100 St. 25 SB
	Duschringe 35 mm oval	weiss klar	R/911-06 R/911-00	R/911-06-SB R/911-00-SB 1 SB = 8St.	100 St. 25 SB
	Stilring PVC 27 x 38 mm für 16 und 20 mm	schwarz	R/915-15	R/915-15-SB 1 SB = 8St.	100 St. 25 SB
	Stilring PVC <i>gedreht</i> 27 x 38 mm für 16 und 20 mm	schwarz	RG/916-15	RG/916-15-SB 1 SB = 8St.	100 St. 25 SB







Abb.	Beschreibung	Farbe	Artikel	VE
 für 12er Rohr	Messing – Ring – rund ohne Gleiteinlage 13 mm x 25 mm	messing.glanz	R/912-08	50 St.
		nickel.matt	R/912-29	50 St.
		verchromt	R/912-14	50 St.
		bronziert	R/912-31	50 St.
		messing.matt	R/912-24	50 St.
 für 12er Rohr	Messing – Ring – rund mit PVC – Einlage 17 mm x 27 mm	messing.glanz	R/912-08-GL	50 St.
		nickel.matt	R/912-29-GL	50 St.
		verchromt	R/912-14-GL	50 St.
		bronziert	R/912-31-GL	50 St.
		messing.matt	R/912-24-GL	50 St.
 für 12er Rohr	Messing – Ring – flach mit PVC – Einlage 17 mm x 25 mm	messing.glanz	RF/912-08-GL	50 St.
		nickel.matt	RF/912-29-GL	50 St.
		verchromt	RF/912-14-GL	50 St.
		bronziert	RF/912-31-GL	50 St.
		messing.matt	RF/912-24-GL	50 St.
 für 16er Rohr	Messing – Ring – rund ohne Gleiteinlage 25 mm x 33 mm	messing.glanz	R/916-08	50 St.
		nickel.matt	R/916-29	50 St.
		verchromt	R/916-14	50 St.
		bronziert	R/916-31	50 St.
		messing.matt	R/916-24	50 St.
 für 16er Rohr	Messing – Ring – rund mit PVC – Einlage 21 mm x 30 mm	messing.glanz	R/916-08-GL	50 St.
		nickel.matt	R/916-29-GL	50 St.
		verchromt	R/916-14-GL	50 St.
		bronziert	R/916-31-GL	50 St.
		messing.matt	R/916-24-GL	50 St.
 für 16er Rohr	Messing – Ring – flach mit PVC – Einlage 24 mm x 29 mm	messing.glanz	RF/916-08-GL	50 St.
		nickel.matt	RF/916-29-GL	50 St.
		verchromt	RF/916-14-GL	50 St.
		bronziert	RF/916-31-GL	50 St.
		messing.matt	RF/916-24-GL	50 St.







Abb.	Beschreibung	Farbe	Artikel	VE
 für 16er Rohr	Messing – Ring – flach ohne Gleiteinlage 24 mm x 29 mm	messing.glanz	RF/916-08	50 St.
		nickel.matt	RF/916-29	50 St.
		verchromt	RF/916-14	50 St.
		bronziert	RF/916-31	50 St.
		messing.matt	RF/916-24	50 St.
 für 20er Rohr	Messing – Ring – rund ohne Gleiteinlage 28 mm x 37 mm	messing.glanz	R/920-08	50 St.
		nickel.matt	R/920-29	50 St.
		verchromt	R/920-14	50 St.
		bronziert	R/920-31	50 St.
		messing.matt	R/920-24	50 St.
 für 20er Rohr	Messing – Ring – rund mit PVC – Einlage 26 mm x 37 mm	messing.glanz	R/920-08-GL	50 St.
		nickel.matt	R/920-29-GL	50 St.
		verchromt	R/920-14-GL	50 St.
		bronziert	R/920-31-GL	50 St.
		messing.matt	R/920-24-GL	50 St.
 für 20er Rohr	Messing – Ring – flach mit PVC – Einlage 26 mm x 34 mm	messing.glanz	RF/920-08-GL	50 St.
		nickel.matt	RF/920-29-GL	50 St.
		verchromt	RF/920-14-GL	50 St.
		bronziert	RF/920-31-GL	50 St.
		messing.matt	RF/920-24-GL	50 St.
 für 20er Rohr	Messing – Ring – flach ohne Gleiteinlage 28 mm x 32 mm	messing.glanz	RF/920-08	50 St.
		nickel.matt	RF/920-29	50 St.
		verchromt	RF/920-14	50 St.
		bronziert	RF/920-31	50 St.
		messing.matt	RF/920-24	50 St.
 für 25er Rohr	Messing – Ring – rund ohne Gleiteinlage 31 mm x 42 mm	messing.glanz	R/925-08	50 St.
		nickel.matt	R/925-29	50 St.
		verchromt	R/925-14	50 St.
		bronziert	R/925-31	50 St.
		messing.matt	R/925-24	50 St.





Abb.	Beschreibung	Farbe	Artikel	VE
 <p>für 25er Rohr</p>	Messing – Ring – flach mit PVC – Einlage 33 mm x 42 mm	messing.glanz	RF/925-08-GL	50 St.
		nickel.matt	RF/925-29-GL	50 St.
		verchromt	RF/925-14-GL	50 St.
		bronziert	RF/925-31-GL	50 St.
		messing.matt	RF/925-24-GL	50 St.
 <p>für 25er Rohr</p>	Messing – Ring – flach ohne Gleiteinlage 34 mm x 40 mm	messing.glanz	RF/925-08	50 St.
		nickel.matt	RF/925-29	50 St.
		verchromt	RF/925-14	50 St.
		bronziert	RF/925-31	50 St.
		messing.matt	RF/925-24	50 St.
 <p>für 28er Rohr</p>	Messing – Ring – rund ohne Gleiteinlage 36 mm x 47 mm	messing.glanz	R/928-08	50 St.
		nickel.matt	R/928-29	50 St.
		verchromt	R/928-14	50 St.
		bronziert	R/928-31	50 St.
		messing.matt	R/928-24	50 St.
 <p>für 28er Rohr</p>	Messing – Ring – rund mit PVC – Einlage 40 mm x 51 mm	messing.glanz	R/928-08-GL	50 St.
		nickel.matt	R/928-29-GL	50 St.
		verchromt	R/928-14-GL	50 St.
		bronziert	R/928-31-GL	50 St.
		messing.matt	R/928-24-GL	50 St.
 <p>für 28er Rohr</p>	Messing – Ring – flach mit PVC – Einlage 39 mm x 48 mm	messing.glanz	RF/928-08-GL	50 St.
		nickel.matt	RF/928-29-GL	50 St.
		verchromt	RF/928-14-GL	50 St.
		bronziert	RF/928-31-GL	50 St.
		messing.matt	RF/928-24-GL	50 St.







Abb.	Beschreibung	Farbe	Artikel	VE
 für 28er Rohr	Messing – Ring – flach	messing.glanz	RF/928-08	50 St.
	ohne Gleiteinlage	nickel.matt	RF/928-29	50 St.
	41 mm x 48 mm	verchromt	RF/928-14	50 St.
		bronziert	RF/928-31	50 St.
		messing.matt	RF/928-24	50 St.
 für 35er Rohr	Messing – Ring – rund	messing.glanz	R/935-08	50 St.
	ohne Gleiteinlage	nickel.matt	R/935-29	50 St.
	48 mm x 60 mm	verchromt	R/935-14	50 St.
		bronziert	R/935-31	50 St.
		messing.matt	R/935-24	50 St.
 für 12er und 16er Rohr	Edelstahl – Ring – flach ohne Gleiteinlage 28 mm x 24 mm x 3 mm mit Faltenleghaken	edelstahl	RS/916-30	100 St.
 für 16er und 20er Rohr	Edelstahl – Ring – flach ohne Gleiteinlage 32 mm x 28 mm x 4 mm mit Faltenleghaken	edelstahl	RS/920-30	100 St.
 für 12er und 16er Rohr	Edelstahl – Ring – flach mit Gleiteinlage 30 mm x 25 mm x 4 mm mit Faltenleghaken	edelstahl	RSZ/916-30	100 St.
 für 16er und 20er Rohr	Edelstahl – Ring – flach mit Gleiteinlage 35 mm x 30 mm x 5 mm mit Faltenleghaken	edelstahl	RSZ/920-30	100 St.

Abb.	Beschreibung	Farbe	Artikel	VE
    verwendbar für 4mm und 6 mm Läufe	Aluminiumpaneele mit eingearbeitetem Klettband 2 Gleiter 1 Mitnehmer 2 Endkappen mit Öse für Schleuderstab 1 Beschwerungsprofil mit Endkappe SB – Verpackt	weiss	SB - 20 – PA – 45cm	10 St.
	weiss	SB - 20 – PA – 60cm	10 St.	
	weiss	SB - 20 – PA – 80cm	10 St.	
	weiss	SB - 20 – PA – 100cm	10 St.	
	weiss	SB - 20 – PA – 120cm	10 St.	

    verwendbar für 4mm und 6 mm Läufe	Aluminiumpaneele mit eingearbeitetem Klettband 2 Gleiter 1 Mitnehmer 2 Endkappen mit Öse für Schleuderstab 1 Beschwerungsprofil mit Endkappe SB – Verpackt	alu.silber	SB - 20 – PA – 45cm	10 St.
	alu.silber	SB - 20 – PA – 60cm	10 St.	
	alu.silber	SB - 20 – PA – 80cm	10 St.	
	alu.silber	SB - 20 – PA – 100cm	10 St.	
	alu.silber	SB - 20 – PA – 120cm	10 St.	

Abb.	Beschreibung	Farbe	Artikel	VE
------	--------------	-------	---------	----



Kunststoffpaneele

mit aufgeklebtem Klettband

2 Gleiter

1 Mitnehmer

2 Endkappen mit Öse für Schleuderstab

1 Beschwerungsprofil mit Endkappe

SB – Verpackt

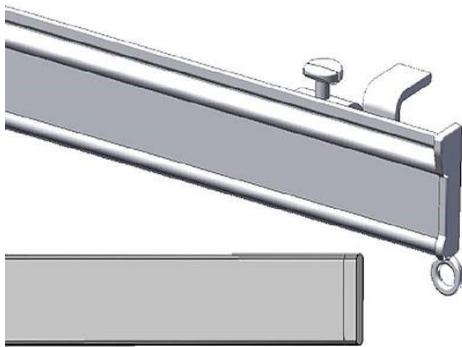

verwendbar für 4mm und 6 mm Läufe

weiss	SB - 20 - PP - 45cm	10 St.
weiss	SB - 20 - PP - 60cm	10 St.
weiss	SB - 20 - PP - 80cm	10 St.
weiss	SB - 20 - PP - 100cm	10 St.
weiss	SB - 20 - PP - 120cm	10 St.



Erkerlösung und Retourenlösung

Gelenk – Verbinder

für Alu- und

Kunststoffpaneele

passend für 4 mm und

6 mm Läufe

silber

20 - PA - GV - 33

10 St.

weiss

20 - PA - GV - 06

10 St.

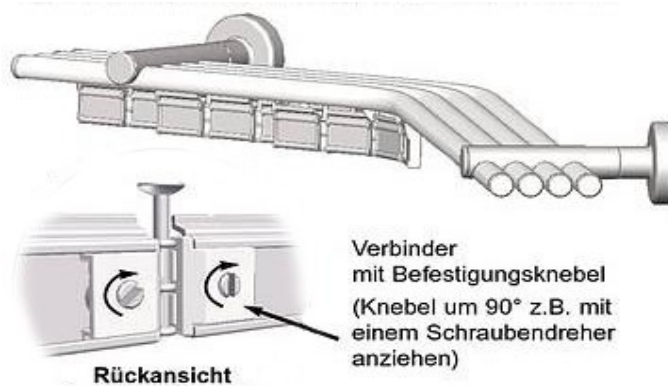

Reststücke von Paneele können als Segmente verwendet werden !

Abb.	Beschreibung	Farbe	Artikel	VE
	Aluminiumpaneele mit eingearbeitetem Klettband	alu/weiss	20 – PA – 50cm	10 St.
		06 = weiss	20 – PA – 60cm	10 St.
		33 = silber	20 – PA – 80cm	10 St.
	Lagerlänge Achtung Frachtanteil	alu/weiss	20 – PA – 600cm	10 St.
	Kunststoffpaneele mit aufgeklebtem Klettband	weiss	20 – PP – 50cm	10 St.
			20 – PP – 60cm	10 St.
			20 – PP – 80cm	10 St.
	Lagerlänge Achtung Frachtanteil	weiss	20 – PP – 600cm	20 St.
	Gleiter für Alu und Kunststoffpaneele passend für 4 mm und 6 mm Läufe	silber	20 – PA – GP – 33	100 St.
		weiss	20 – PA – GP – 06	100 St.
	mit X - Gleiter Gleiter für Alu und Kunststoffpaneele passend für 6 mm Läufe Einfache Montage ! Beste Gleiteigenschaften !	weiss	20 – PA – X 6	100 St.
				
	mit Gleitschuh Gleiter für Alu und Kunststoffpaneele passend für 4 mm Läufe Einfache Montage ! Beste Gleiteigenschaften !	weiss	20 – PA 4	100 St.
				
	Flach – Feststeller für Läufe 4 mm für Läufe 6 mm	klar	115 – 4 mm	100 St.
			115 – 6 mm	100 St.

Abb.	Beschreibung	Farbe	Artikel	VE
 	Mitnehmer für Alu- und Kunststoffpaneele	silber	20 – PA – M – 33	20 St.
		weiss	20 – PA – M – 06	20 St.
 	Kappen für Alu- und Kunststoffpaneele links & rechts mit Öse für Schleuderstab	silber	links & rechts 20 – PA – SO – 33	20 St.
		weiss	20 – PA – SO – 06	20 St.
 	Gelenk – Verbinder für Alu- und Kunststoffpaneele passend für 4 mm und 6 mm Läufe	silber	20 – PA – GV – 33	10 St.
		weiss	20 – PA – GV – 06	10 St.
 	Kappen für für Alupaneele links & rechts	weiss	links & rechts 20 – PK – 06	20 St.
 	Kappen für Kunststoff – Paneele links & rechts	weiss	links & rechts 20 – PK – PL – 06	20 St.
 	Gleitwagen für Alu- und Kunststoffpaneele mit Clipöse für Ringe mit 4 mm – Kerbe	weiss	ohne Ring 20 – PA – G4 – 06	100 St.
 	Ring 25 x 32 mm für Stil 16 mm Ringkerbe 4 mm PVC	weiss	ohne Gleitwagen 325 – 06	100 St.
		schwarz	325 – 15	100 St.
		chrom.matt	325 – 33	100 St.
		edelstahl	325 – 30	100 St.
		mess.matt	325 – 24	100 St.

















Abb.	Beschreibung	Farbe	Artikel	VE
 	Beschwerungsprofil 25 x 3 mm Kunststoff 85g per Meter abgerundete Kanten	transparent	600 cm Lagerlänge 07.25 – 3 Achtung Frachtanteil	20
 	Beschwerungsprofil 20 x 3 mm Aluminium 160g per Meter abgerundete Kanten	weiss	600 cm Lagerlänge 07.20 – 3 Achtung Frachtanteil	20
 PVC	Endkappe für Profil 20 x 3 mm PVC	weiss	07.20 – K 3	100
   PVC	Beschwerungsprofil 20 x 5 mm Aluminium 270g per Meter abgerundete Kanten	weiss	600 cm Lagerlänge 07.20 – 5 Achtung Frachtanteil	20
 PVC	Endkappe für Profil 20 x 5 mm PVC	weiss	07.20 – K 5	100
	Flachstab alu eloxiert 25 x 3 mm	silber	FV/990-245cm -33	10
 PVC	Endkappe für Artikel Alu Flachstab FV/990-245cm - 33 und Beschwerungsprofil 07.25 – 3 Kunststoff	silber transparent	FV/994-33 FV/994-00	20 20

Abb.	Beschreibung	Farbe	Artikel	VE
	Universal - Gleiter für Flächenvorhang Laufnut 4 – 6 mm für Artikel FV/990-245cm -33 und 07.25 – 3	weiss	FV/991-06	100 St.
	Roll – Gleiter für Flächenvorhang für alle gängigen Innenlaufschienen für Artikel Alu Flachstab FV/990-245cm - 33 und Beschwerungsprofil 07.25 – 3	weiss	FV/992-06	100 St.
	X – Gleiter für Flächenvorhang Laufnut 6 mm für Artikel Alu Flachstab FV/990-245cm - 33 und Beschwerungsprofil 07.25 – 3		FV/993-06	100 St.
	Paneelclip für Flächenvorhang Leer für Artikel Alu Flachstab FV/990-245cm - 33 und Beschwerungsprofil 07.25 – 3		FV/994-06	100 St.
	Flachstab alu eloxiert 25 x 3 mm	silber	FV/990-245cm -33	10
	 Beschwerungsprofil 25 x 3 mm Kunststoff 85g per Meter abgerundete Kanten	transparent	600 cm Lagerlänge 07.25 – 3	20 Achtung Frachtanteil

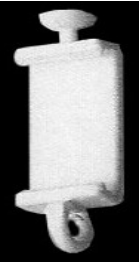
Muster anfordern, kostenlos unter Fax. 08331 / 961872 – 1

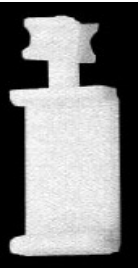
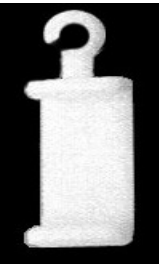

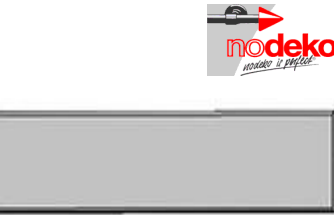







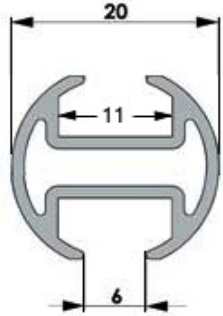
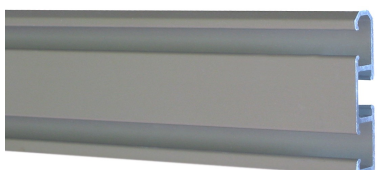

Abb.	Beschreibung	Farbe	Artikel	VE
			Lagerlänge 600 cm	
	Innenlauf Rohr 20mm	weiss	20/600-06	10
	Lagerlänge 600 cm	silber	20/600-33	10
	Laufnut 6 mm	vermessingt	20/600-07	10
		V2A.Farbe	20/600-29	10
				Zuschnitt
	weiss	20/Länge-06		
	silber	20/Länge-33		
	vermessingt	20/Länge-07		
	V2A.Farbe	20/Länge-29		
			Lagerlänge 600 cm	
	1 bis 2 Lauf-Schiene	weiss	12/600-06	10
		silber	12/600-33	10
			Zuschnitt	
		weiss	12/Länge-06	
		silber	12/Länge-33	
			Lagerlänge 600 cm	
	Endkappe	weiss	12/Kappe-06	10
	1 bis 2 Lauf-Schiene	silber	12/Kappe-33	10
			Lagerlänge 600 cm	
	3 bis 4 Lauf-Schiene	weiss	34/600-06	10
		silber	34/600-33	10
			Zuschnitt	
		weiss	34/Länge-06	
		silber	34/Länge-33	
			Lagerlänge 600 cm	
	Endkappe	weiss	34/Kappe-06	10
	3 bis 4 Lauf-Schiene	silber	34/Kappe-33	10
			Lagerlänge 600 cm	
	Befestigungssatz bestehend aus:			
	Schraube 4,5 x 40mm	weiss		
	Abdeckkappe PVC weiss / grau	silber		
	Bohrloch versenkt			

Abb.	Beschreibung	Farbe	Artikel	VE
Lagerlänge 600 cm				
driplex 	3 Lauf – Schiene alu selbsttragend	weiss	3/600-06	5
		silber	3/600-33	5
		Zuschnitt weiss 3/Länge-06 silber 3/Länge-33		
driplex 	Endkappe für Schiene 3 lauf PVC	weiss	3/Kappe-06	10
		silber	3/Kappe-33	10
Deckenträger PVC				
		grau	3/DT	10
driplex 	Wandträger ALU sehr stabile Ausführung Universal	weiss	U/WT – 06	10
		silber	U/WT – 33	10
driplex 	Wandträger ALU kürzbar / 12,5 cm	weiss	WT/3 – 06	10
		silber	WT/3 – 33	10
		vermessingt	WT/3 – 07	10
		nickel.matt	WT/3 – 29	10
driplex 	Deckenträger metall	verzinkt	DT/26 – 33	10

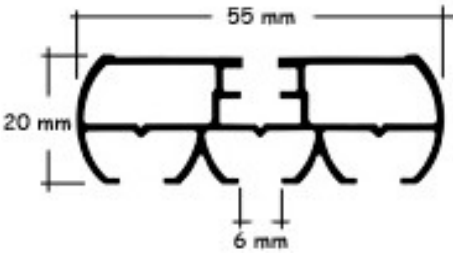
16 mm Edelstahl

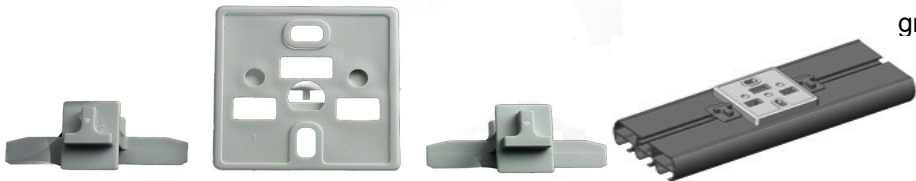

Träger 16 mm

Nr. 1601 – 30

per Stück
VE 10 Stück



Träger 16 mm

Nr. 1601 – S - 30

per Stück
VE 10 Stück

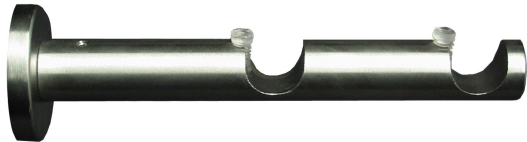

Träger 2 lauf 16 mm

Nr. 1602 – 30

per Stück
VE 10 Stück

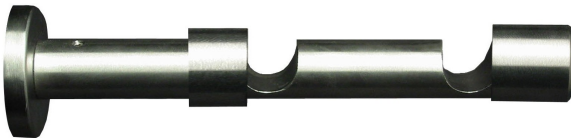

Träger 2 lauf 16 mm

Nr. 1602 – S – 30

per Stück
VE 10 Stück



Wandlager 16 mm

Nr. 1606 – 30

per Stück
VE 5 Stück



V2A – Rohr 16 mm

16 mm x 0,6 mm
600 cm Längen
160 cm Fixlänge
200 cm Fixlänge
240 cm Fixlänge

per Meter
Nr. 1600-30-06-Länge
VE 20 Stück
VE 10 Stück
VE 10 Stück
VE 10 Stück



V2A – Ring 16 mm

28x24x3 mm



V2A – Ring 16 mm

30x25x4 mm

mit Gleiteinlage

Endkappe

Nr. 1603 – 30 **VE 10 Stück**



Rillenkugel

Nr. 1605 – 30 **VE 10 Stück**



Rillenkegel

Nr. 1604 – 30 **VE 10 Stück**



Rillenpatrone

Nr. 1607 – 30 **VE 10 Stück**



Spitze Bicolor

Nr. 1608 – 30 **VE 10 Stück** messing od. schwarz

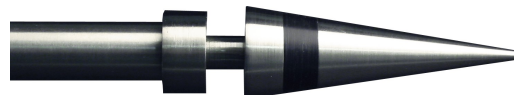

Gelenkverbinder



V2A Garnituren 16 mm mit Auflageträger

Die Garnitur besteht aus: Endstücke, Einlegeträger, Flachringe mit Haken und dem Rohr, alles aus Edelstahl.

Patrone



Spitze



Kugel

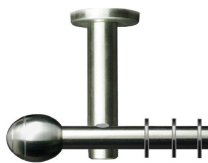

Bei der 2 läufigen Garnitur wird der zweite Lauf mit Kappe ausgeliefert

ab 200 cm 1 Träger zusätzlich.
ab 400 cm 2 Träger zusätzlich.



Abschlag Wandlager einseitig :

15,90 €

14,30 €

Länge	Anzahl Ringe	Preis	Anzahl Ringe	Preis
	1 läufig	1 läufig	2 läufig	2 läufig
100 cm	14	97,80 €	28	160,40 €
120 cm	16	102,70 €	32	170,20 €
140 cm	20	109,80 €	40	184,40 €
160 cm	22	114,70 €	44	194,20 €
180 cm	24	119,60 €	48	204,00 €
200 cm	28	143,70 €	56	240,70 €
220 cm	30	148,60 €	60	250,50 €
240 cm	34	155,70 €	68	264,70 €
260 cm	36	160,60 €	72	274,50 €
280 cm	38	165,50 €	76	284,30 €
300cm	42	172,60 €	84	298,50 €
320 cm	44	177,50 €	88	308,30 €
340 cm	48	184,60 €	96	322,50 €
360 cm	50	189,50 €	100	332,30 €
380 cm	52	194,40 €	104	342,10 €
400 cm	56	218,50 €	112	378,80 €
		4 Träger		4 Träger

Unverbindlich empfohlene VK-Preise inkl. MwSt.

Alle Garnituren werden ab 220cm geteilt mit Verbinder ausgeliefert!

V2A Garnituren 16 mm mit Auflageträger

Die Garnitur besteht aus:
Einlegeträger, Flachringe mit Haken
und dem Rohr, alles aus
Edelstahl.

Spitze mit schwarz



Spitze mit messing

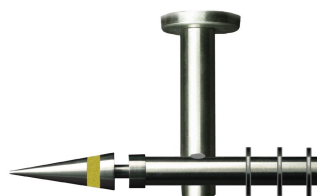

**Bei der 2 läufigen
Garnitur wird der
zweite Lauf mit Kappe
ausgeliefert**

ab 200 cm 1 Träger zusätzlich.
ab 400 cm 2 Träger zusätzlich.



Abschlag Wandlager einseitig :

31,00 €

29,30 €

Länge	Anzahl Ringe	Preis	Anzahl Ringe	Preis
	1 läufig	1 läufig	2 läufig	2 läufig
100 cm	14	127,90 €	28	190,40 €
120 cm	16	132,80 €	32	200,20 €
140 cm	20	139,90 €	40	214,40 €
160 cm	22	144,80 €	44	224,20 €
180 cm	24	149,70 €	48	234,00 €
200 cm	28	173,80 €	56	270,70 €
220 cm	30	178,70 €	60	280,50 €
240 cm	34	185,80 €	68	294,70 €
260 cm	36	190,70 €	72	304,50 €
280 cm	38	195,60 €	76	314,30 €
300cm	42	202,70 €	84	328,50 €
320 cm	44	207,60 €	88	338,30 €
340 cm	48	214,70 €	96	352,50 €
360 cm	50	219,60 €	100	362,30 €
380 cm	52	224,50 €	104	372,10 €
400 cm	56	248,60 €	112	434,00 €
		4 Träger		4 Träger

Unverbindlich empfohlene VK-Preise inkl. MwSt.

Alle Garnituren werden ab 220cm geteilt mit Verbinder ausgeliefert!

16 mm Garnituren Eisen Nr. 9500 – Mix



Die Garnitur besteht aus:
Träger ausziehbar,
dem Metallohr PVC ummantelt,
und Ringe rund PVC mit Haken

Länge	Anzahl Ringe	Preis	Anzahl Ringe	Preis
	1 läufig	1 läufig	2 läufig	2 läufig
100 cm	14	42,50 €	28	66,20 €
120 cm	16	44,80 €	32	70,70 €
140 cm	20	47,90 €	40	76,80 €
160 cm	22	49,90 €	44	81,30 €
180 cm*	24	61,50 €	48	97,00 €
200 cm	28	64,50 €	56	103,10 €
220 cm	30	68,00 €	60	107,60 €
240 cm	34	71,70 €	68	113,50 €
260 cm	36	75,60 €	72	120,00 €
280 cm	38	79,70 €	76	126,60 €
300cm	42	84,00 €	84	133,50 €
320 cm	44	88,60 €	88	141,00 €
340 cm	48	93,50 €	96	149,00 €
360 cm	50	98,60 €	100	157,00 €
380 cm	52	104,00 €	104	165,50 €
400 cm*	56	118,72 €	112	185,80 €
		4 Träger		4 Träger

**Bei der 2 läufigen
Garnitur wird der
zweite Lauf mit Kappe
ausgeliefert**

ab 180 cm 1 Träger zusätzlich.
ab 400 cm 2 Träger zusätzlich.

Abschlag Wandlager einseitig :

11,20 €

13,10 €

Unverbindlich empfohlene VK-Preise inkl. MwSt.

Alle Garnituren werden ab 220cm geteilt mit Verbinder ausgeliefert!

* + 1 Träger

20 mm Garnituren „CHROME“

SOmmer
GArdinen
TEChnik

GROSSHANDEL FÜR
GARDINENTECHNIK

Innenlauf Träger



Nr. 152



Nr. 153



Nr. 154



Nr. 155



**Bei der 2 läufigen
Garnitur wird der
zweite Lauf mit Kappe
ausgeliefert**

ab 200 cm 1 Träger zusätzlich.
ab 400 cm 2 Träger zusätzlich.



Abschlag Wandlager einseitig :

10,00 €

13,10 €

Länge	Anzahl Ringe		Preis	
	1 läufig	2 läufig	1 läufig	2 läufig
100 cm	14	28	192,10 €	287,10 €
120 cm	16	32	202,30 €	307,10 €
140 cm	20	40	215,95 €	265,95 €
160 cm	22	44	226,15 €	327,10 €
180 cm	24	48	236,30 €	347,10 €
200 cm*	28	56	290,90 €	406,35 €
220 cm	30	60	300,20 €	426,35 €
240 cm	34	68	313,95 €	447,35 €
260 cm	36	72	324,15 €	469,35 €
280 cm	38	76	334,35 €	492,35 €
300cm	44	84	350,90 €	516,35 €
320 cm	48	88	364,65 €	541,85 €
340 cm	50	96	378,65 €	567,85 €
360 cm	52	100	392,65 €	595,35 €
380 cm	54	104	406,65 €	623,35 €
400 cm*	56	112	448,65 €	691,85 €
		4 Träger		4 Träger

Unverbindlich empfohlene VK-Preise inkl. MwSt.

Alle Garnituren werden ab 200cm geteilt mit Verbinder ausgeliefert!

Aufbau der Bestellnummer :	Durchmesser	Länge	Endstück	Wandlager	Innenlauf
	20	180 cm	152	1 WL	2 Lauf

Unsere Geschäftsbedingungen (AGB) für den Großhandel

Die nachstehenden Verkaufs- und Lieferbedingungen gelten mit Erteilen des Auftrags und für alle künftigen Geschäfte als vom Besteller anerkannt und rechtsverbindlich. Abweichende Vereinbarungen bedürfen zu ihrer Rechtsgültigkeit unserer schriftlichen Bestätigung.

Verpackungseinheiten

Die Preise gelten grundsätzlich für Verpackungseinheiten (VE, s. Preisliste). Bestellungen unterhalb der Verpackungseinheiten werden mit einem Mindermengenaufschlag von 20% berechnet.

Versand- / Transportkosten

Die Versandkosten pro Paket (bis 31,5 kg) innerhalb Deutschland betragen bei einem Warenwert unter € 50 immer € 7,50, bei Sendungen per Nachnahme € 15,95. Ausgenommen hiervon sind Lieferungen von Lagerlängen (z. B. Schienen oder Stangenware über 210cm) ebenso wie sonstiges Sperrgut bzw. Pakete mit Übermaß. Hier werden bei einem Warenwert unter 750€ die jeweiligen Transportkosten unserer Logistikpartner weiterberechnet.

Lieferung

Wir liefern auf dem schnellsten Wege per GLS, UPS oder Spedition - in der Regel innerhalb weniger Tage. Bedenken Sie aber, dass unsere Produkte zum Teil keine Massenartikel sind. Nicht immer werden wir längere Lieferzeiten vermeiden können. In solchen Fällen können wir Ihren Auftrag auch in Teillieferungen ausführen. Der Versand erfolgt ausschließlich auf Gefahr und Rechnung des Empfängers. Bei Beschädigungen auf dem Transportweg wenden Sie sich bitte an das Transportunternehmen (z. B. GLS, UPS).

Rückgaberecht / Mängel

Die Rücksendungen sind vorab mit uns (SoGaTec) 08331-961872-0 abzusprechen. Einzelstücke können innerhalb von 14 Tagen ab dem Rechnungsdatum - nur unbenutzt und in unserer Originalverpackung - zurückgeschickt werden. Zugeschnittene Ware, alle Sonder- und Einzelanfertigungen sowie Sonderangebote sind vom Umtausch ausgeschlossen. Bitte notieren Sie auf der Rechnerkopie den Grund der Rücksendung. Die Kosten der Rücksendung gehen zu Ihren Lasten. Bitte nur als Postpaket und ausreichend frankiert zurücksenden. Wir behalten uns ein Nachbesserungsrecht vor sowie eine Kostenpauschale von mindestens 10% des Nettowarenwertes zu berechnen. Offensichtliche Mängel sind uns sofort, spätestens aber innerhalb von 7 Tagen nach der Lieferung zu melden.

Zahlungsbedingungen

Unsere Rechnungen sind innerhalb 14 Tagen ab Rechnungsdatum rein netto zahlbar, innerhalb 8 Tagen ab Rechnungsdatum mit 3% Skonto. Bei Zielüberschreitung von mehr als 28 Tagen behalten wir uns vor, bankübliche Zinsen ab Fälligkeit zu berechnen. Eine Zurückhaltung von Zahlungen oder eine Aufrechnung nicht anerkannter Gegenansprüche mit dem Kaufpreis ist ausgeschlossen. Des Weiteren sind wir berechtigt € 2,50 für die erste Mahnung (Zahlungsaufforderung) zu berechnen. Bis zur vollständigen Bezahlung bleiben die gelieferten Waren unser Eigentum.

Preise

Alle Angebote sind freibleibend. Irrtümer, Druckfehler, Produkt- und Preisänderungen bleiben uns ausdrücklich vorbehalten. Die Preise verstehen sich, wenn nicht anders angegeben, rein netto in Euro zuzüglich der gesetzlichen Mehrwertsteuer und Transport- bzw. Versandkosten.

Sonstiges

Mit Erscheinen einer neuen Preisliste verlieren alle früheren Preislisten ihre Gültigkeit. Die Unwirksamkeit einzelner Bedingungen berührt die Gültigkeit der übrigen Regelungen nicht. Erfüllungsort und Gerichtsstand ist Memmingen.

Sommer Gardinentechnik Großhandel

Stand 2010

Augsburger Str. 7

87700 Memmingen